

# Standard Booth - Showcase Booth Fascia & Carpet Color

Size: 1940mmW x 350mmH



10-11 SEPTEMBER 2026 | HONG KONG  
ASIA'S HUB FOR CLIMATE ACTION & SUSTAINABLE BUSINESS SOLUTIONS

## Fascia Color (By Zone)

## Carpet Color (By Zone)



**Showcase Booth (Innovation Zone)**



V0510 Fuschia



**Showcase Booth (Resources Zone)**



V4959 Bluestar



**Showcase Booth (Impact Zone)**



V0400 Yellow



**Showcase Booth (Energy Zone)**



V0700 Brightred



**Showcase Booth (Cities Zone)**



V0520 Violet

Revised Date: 27 May 2026 (V05)

The drawing is the property of AMC (Exhibits) Ltd and we reserve the copyright to all our designs which cannot be reproduced (whether part / whole or modified) without first obtaining our written consent. Contravention will be prosecuted. The drawing is subjected to modification of its design & measurement from time to time to suit construction purpose.



# Standard Booth (A) - 3m x 1m

Size: 3000mmL x 1000mmD x 2440mmH



10-11 SEPTEMBER 2026 | HONG KONG  
ASIA'S HUB FOR CLIMATE ACTION & SUSTAINABLE BUSINESS SOLUTIONS

## Perspective View

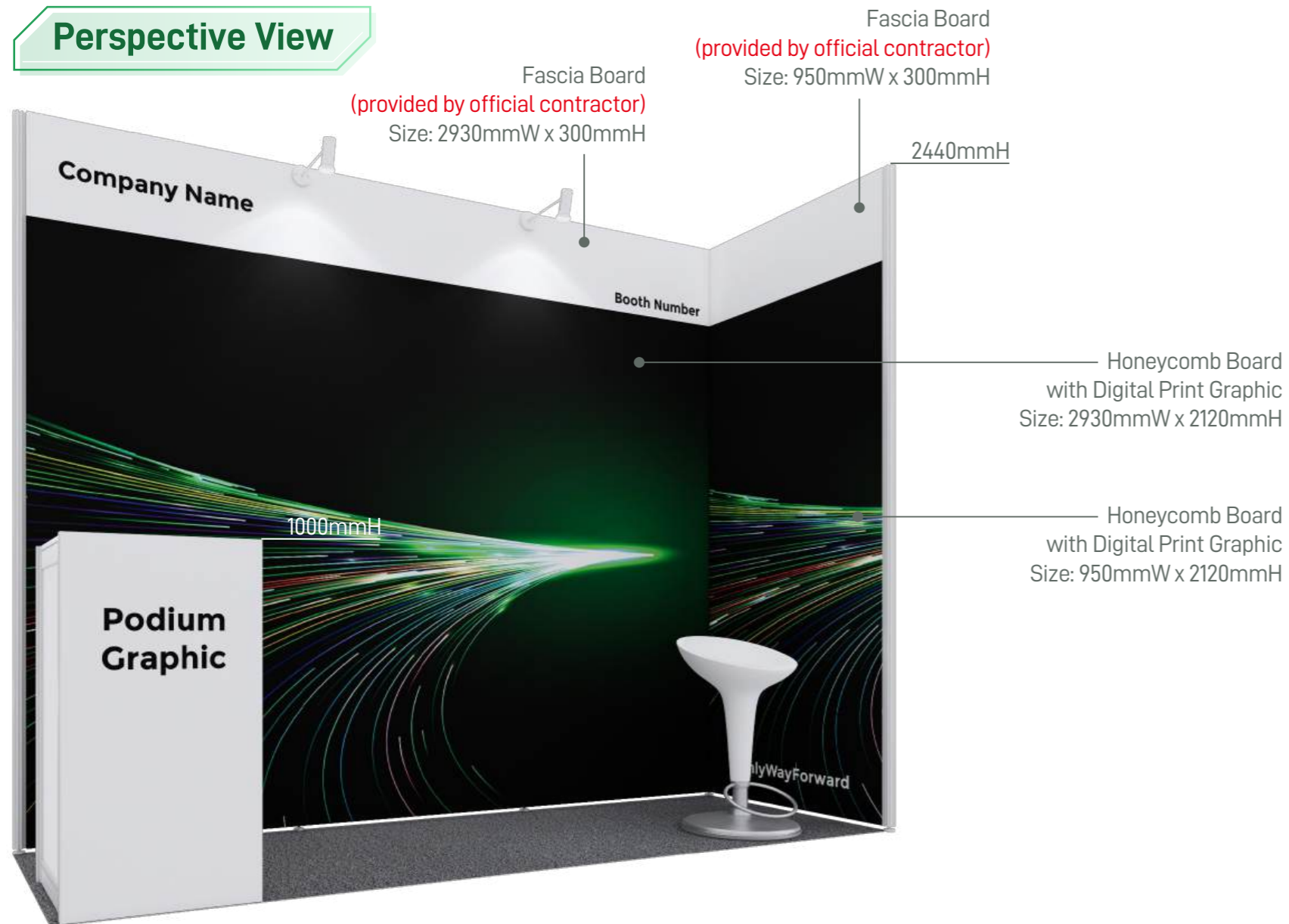

## Layout plan

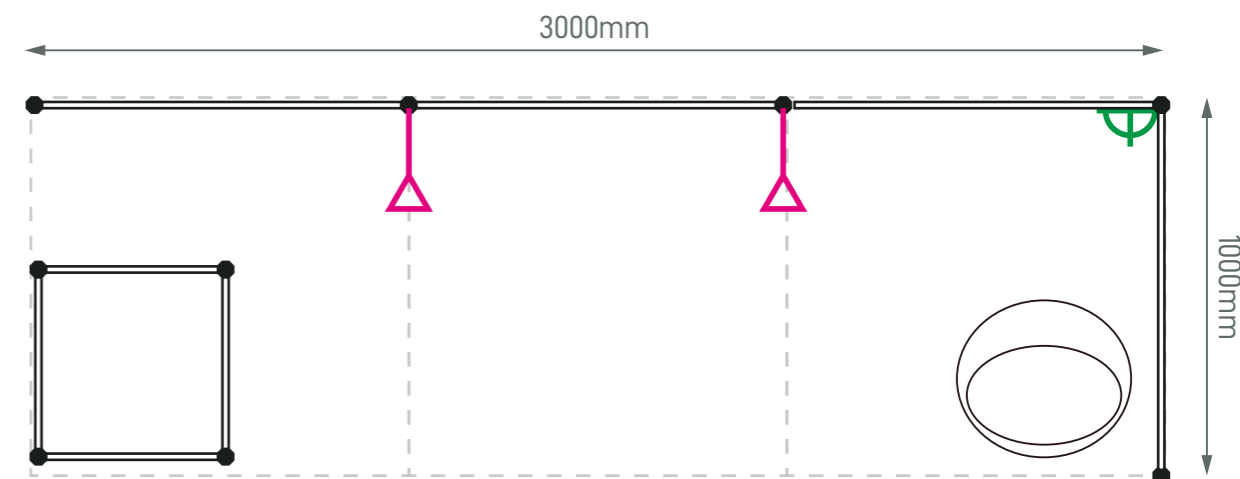

## Graphic Submission

Display Area / Graphic Size:  
2930mmW x 2120mmH

Display Area / Graphic Size:  
950mmW x 2120mmH

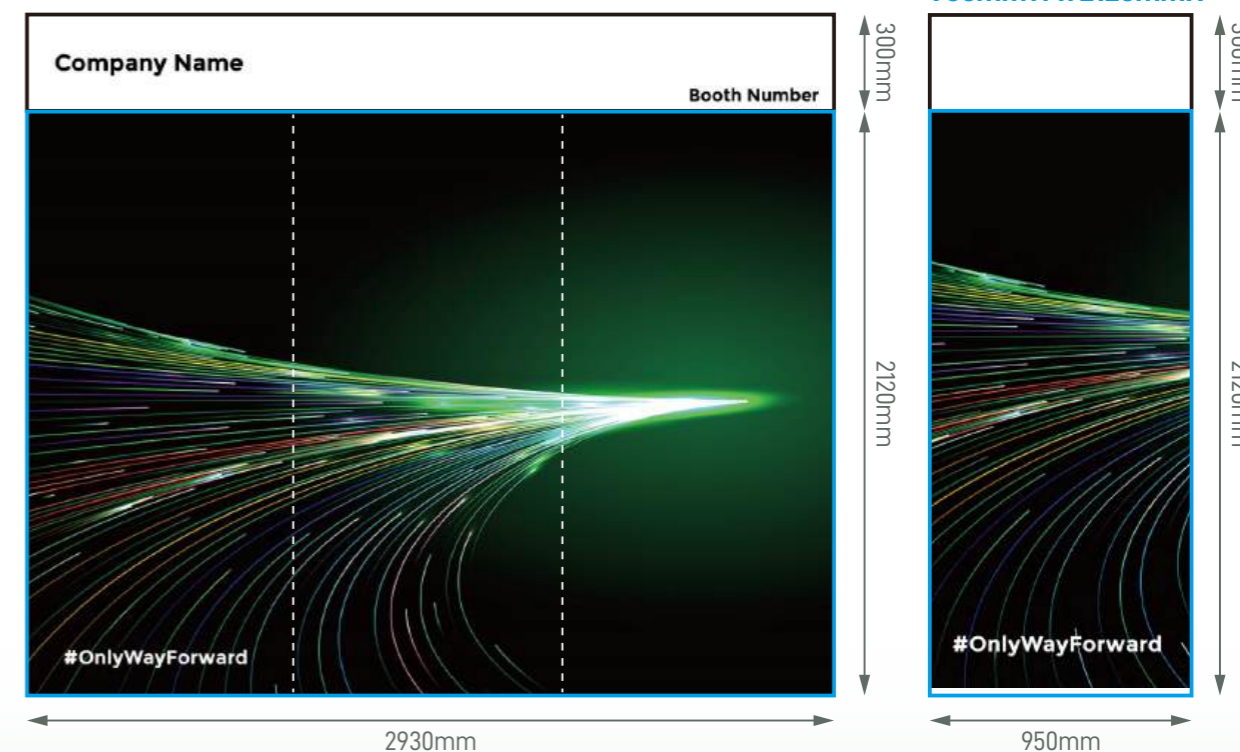

### Legend

	Qty
	2
	1
	1
	1

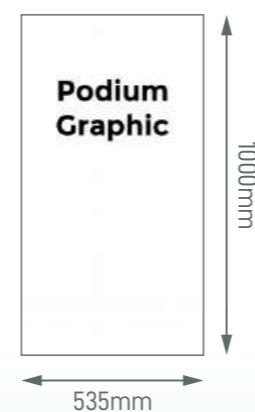

Revised Date: 27 May 2026 (V05)

The drawing is the property of AMC (Exhibits) Ltd and we reserve the copyright to all our designs which cannot be reproduced (whether part / whole or modified) without first obtaining our written consent. Contravention will be prosecuted. The drawing is subjected to modification of its design & measurement from time to time to suit construction purpose.

**amc**  
AMC (Exhibits) Ltd  
建同展覽有限公司

# Standard Booth (A0) - 3m x 1m

Size: 3000mmL x 1000mmD x 2440mmH



10-11 SEPTEMBER 2026 | HONG KONG  
ASIA'S HUB FOR CLIMATE ACTION & SUSTAINABLE BUSINESS SOLUTIONS

## Perspective View

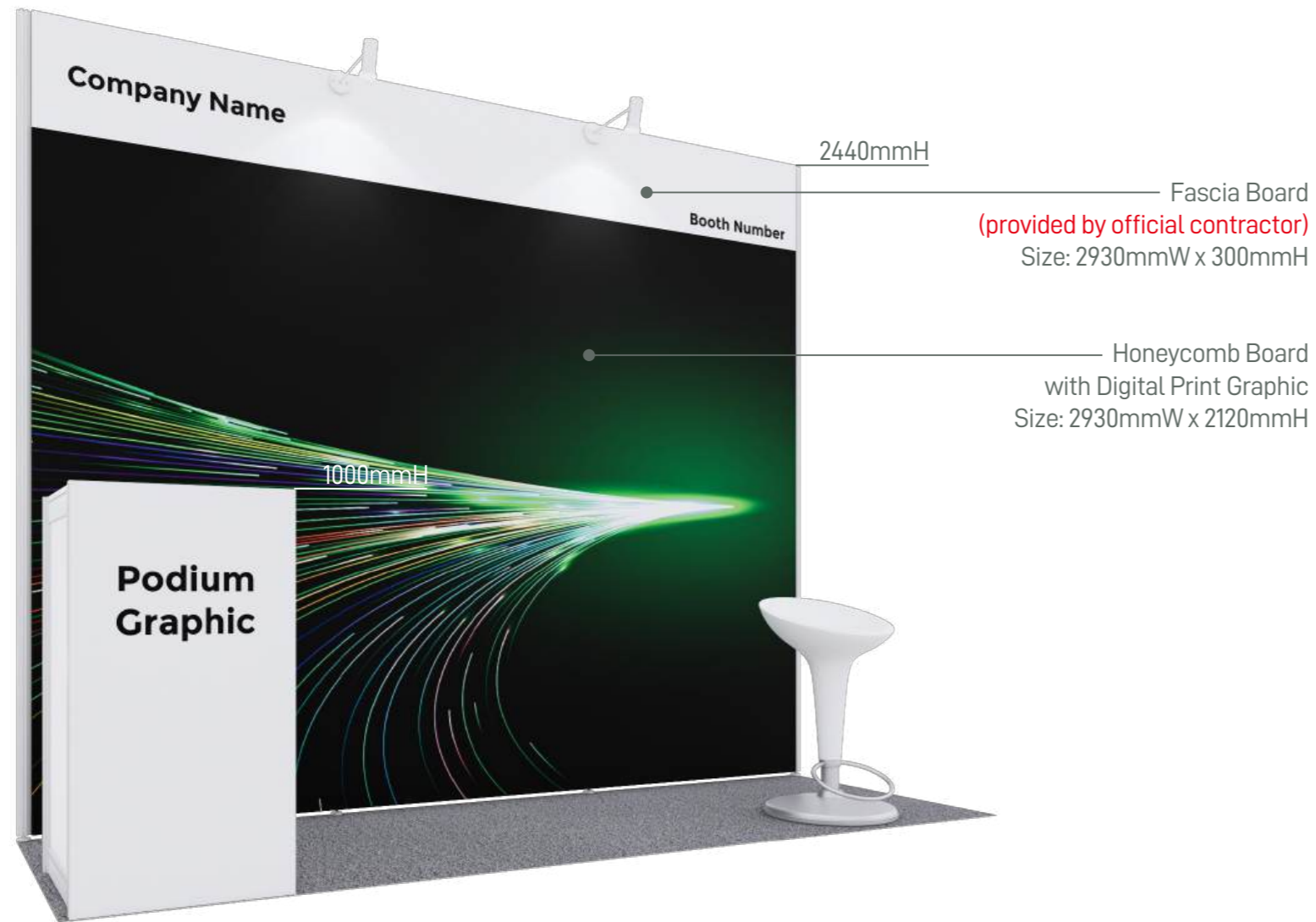

## Layout plan

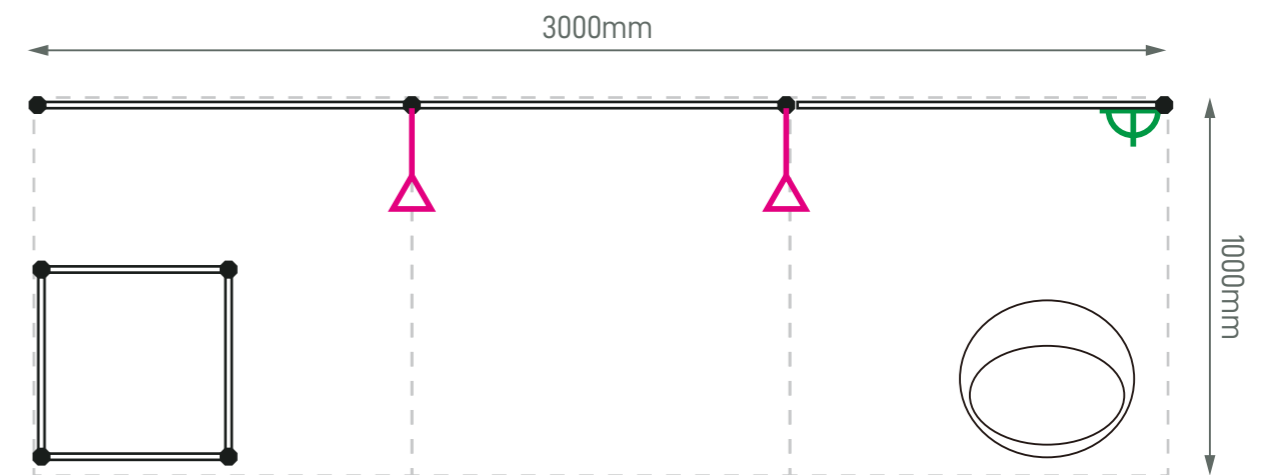

## Graphic Submission

Display Area / Graphic Size:  
2930mmW x 2120mmH

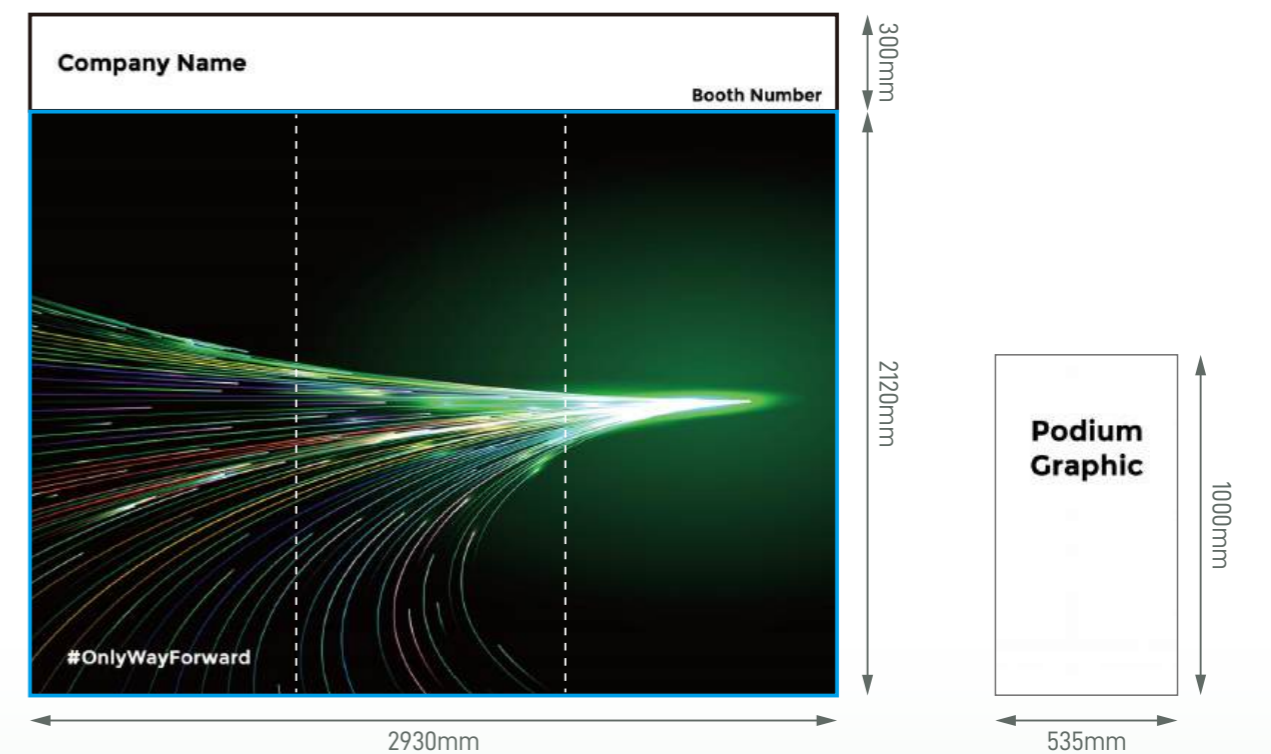

### Legend

	Qty
	2
	1
	1
	1

Revised Date: 27 May 2026 (V05)

The drawing is the property of AMC (Exhibits) Ltd and we reserve the copyright to all our designs which cannot be reproduced (whether part / whole or modified) without first obtaining our written consent. Contravention will be prosecuted. The drawing is subjected to modification of its design & measurement from time to time to suit construction purpose.

# Standard Booth (A1) - 2m x 2m

Size: 2000mmL x 2000mmD x 2440mmH



10-11 SEPTEMBER 2026 | HONG KONG  
ASIA'S HUB FOR CLIMATE ACTION & SUSTAINABLE BUSINESS SOLUTIONS

## Perspective View



## Layout plan

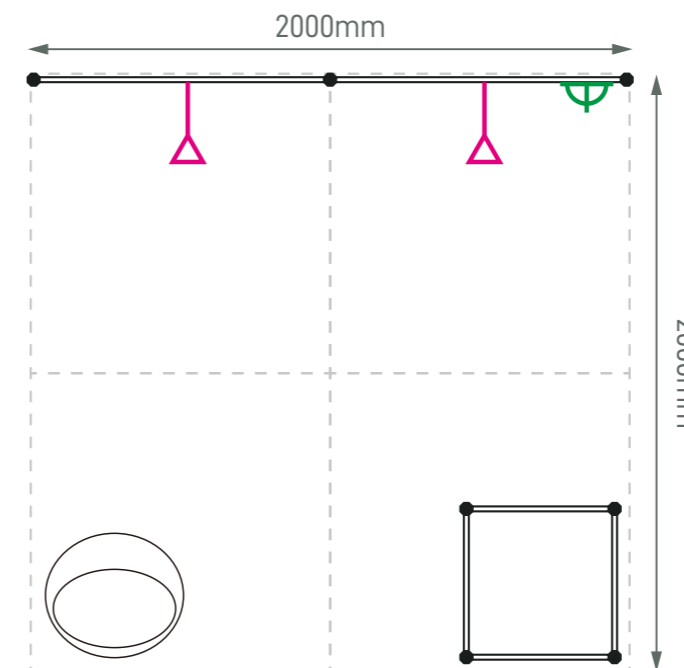

## Graphic Submission

Display Area / Graphic Size:  
1940mmW x 2120mmH

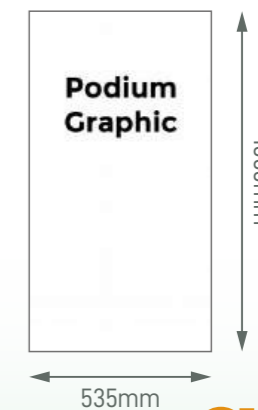
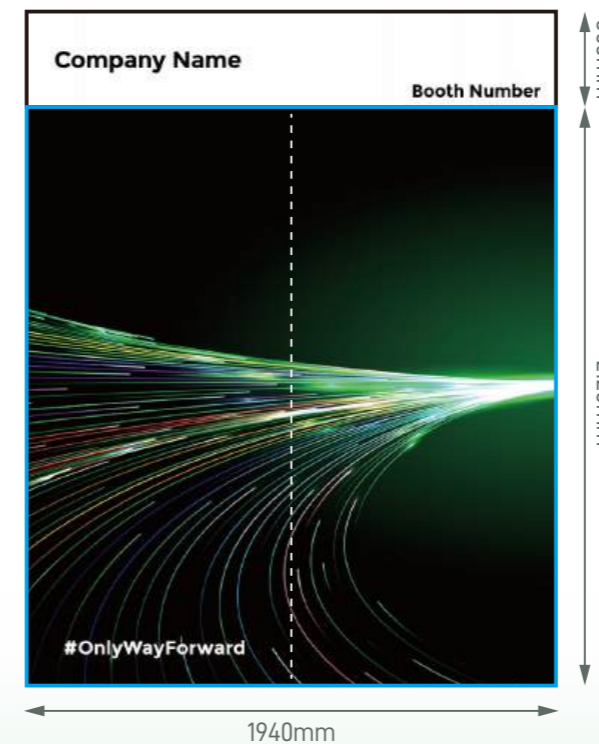

### Legend

	Qty
	2
	1
	1
	1

Revised Date: 27 May 2026 (V05)

# Standard Booth (A2L) - 2m x 2m

Size: 2000mmL x 2000mmD x 2440mmH

( Left opened )



10-11 SEPTEMBER 2026 | HONG KONG  
ASIA'S HUB FOR CLIMATE ACTION & SUSTAINABLE BUSINESS SOLUTIONS

## Perspective View

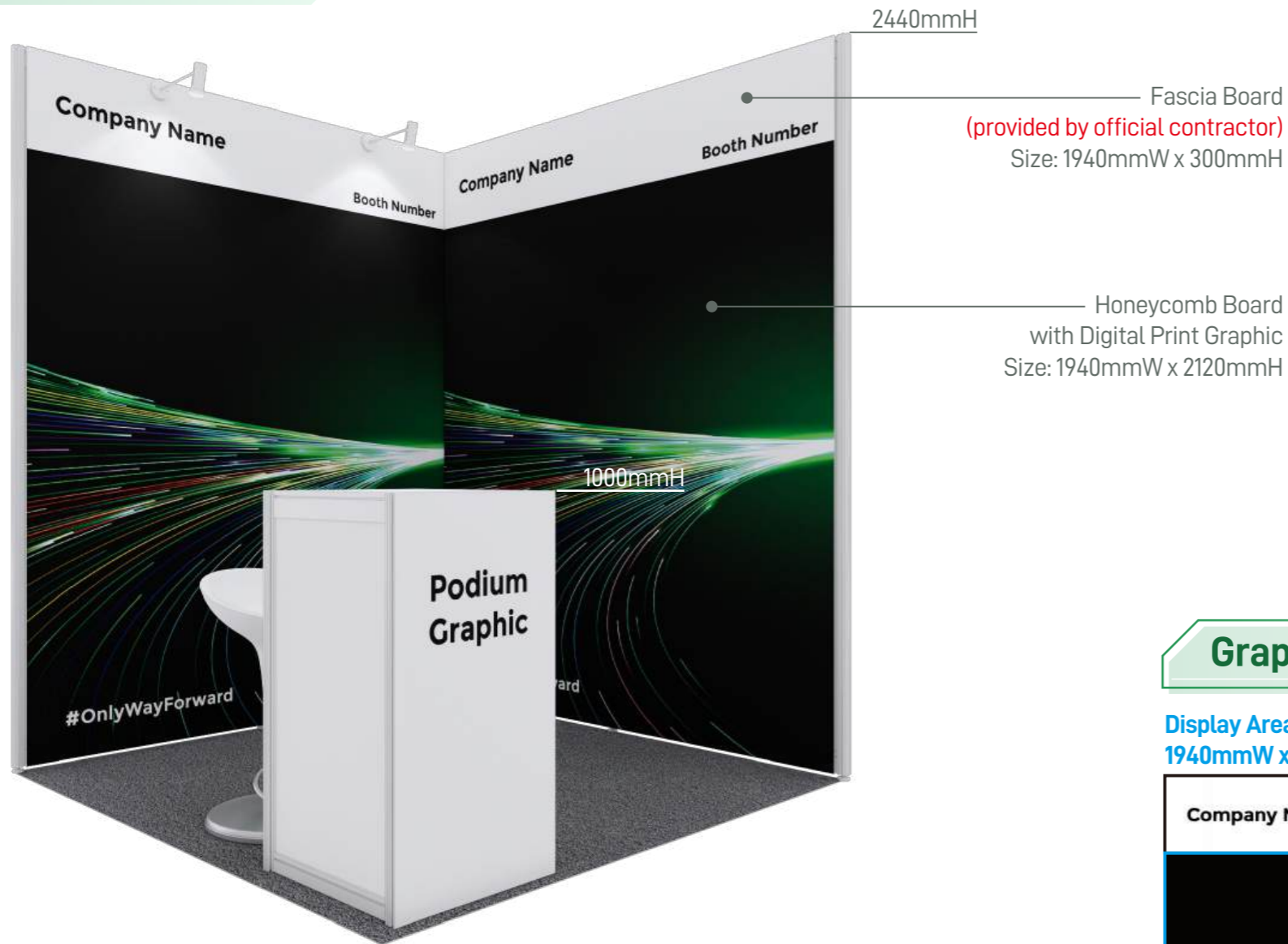

## Layout plan

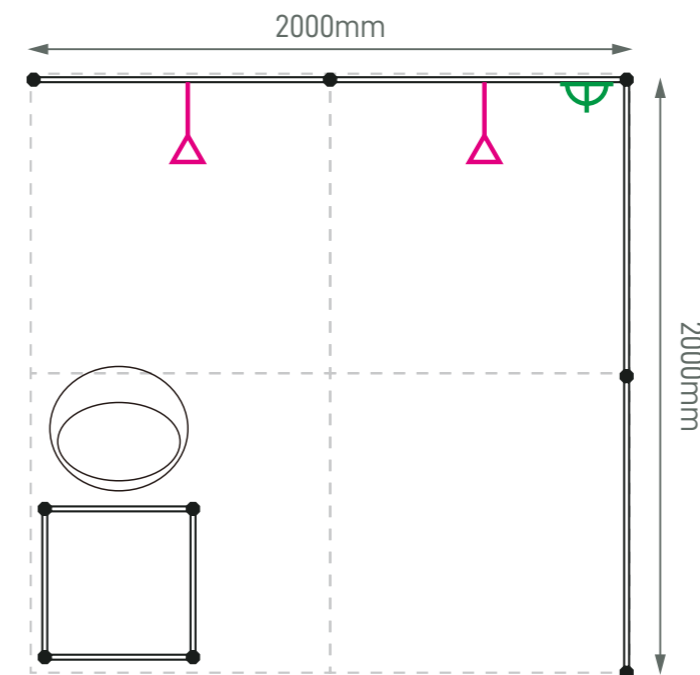

## Graphic Submission

Display Area / Graphic Size:  
1940mmW x 2120mmH

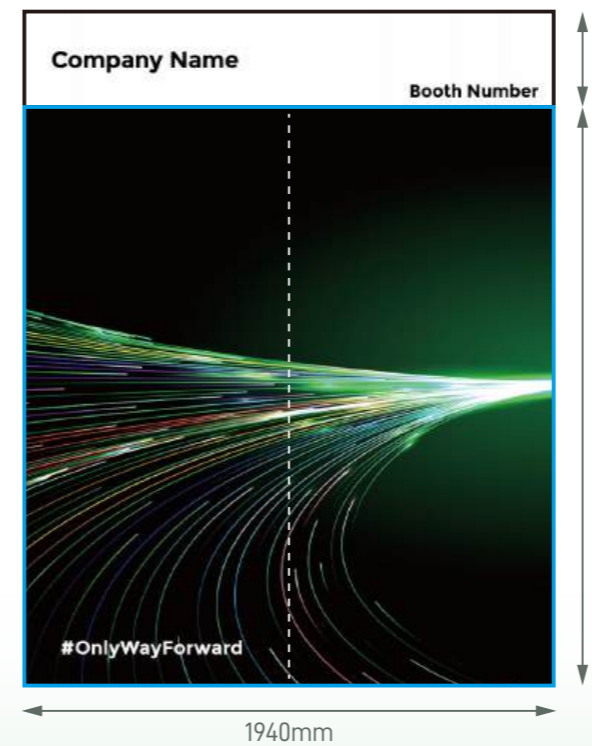

Display Area / Graphic Size:  
1940mmW x 2120mmH

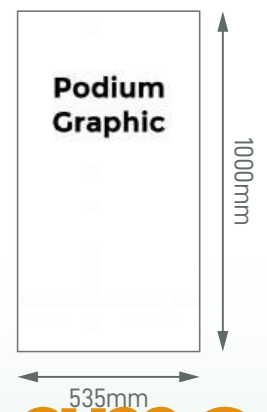
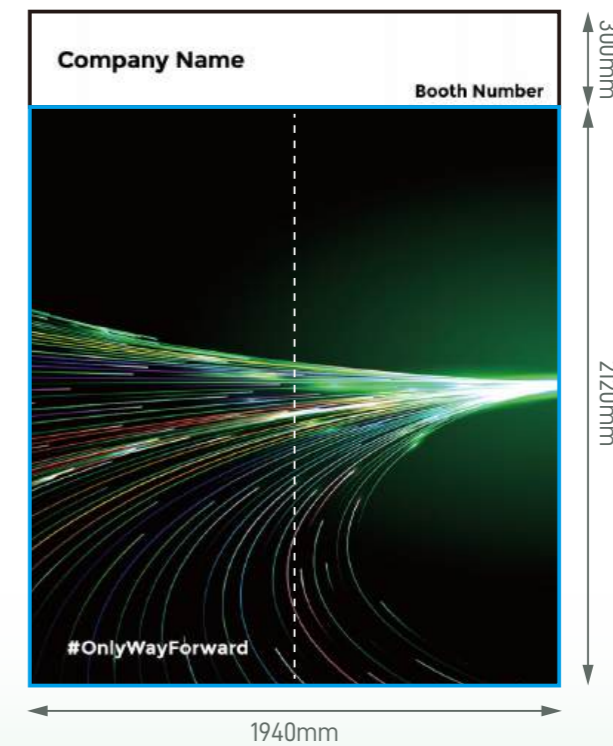

### Legend

	Qty
	2
	1
	1
	1

Revised Date: 27 May 2026 (V05)

# Standard Booth (A2R) - 2m x 2m

Size: 2000mmL x 2000mmD x 2440mmH

( Right opened )



10-11 SEPTEMBER 2026 | HONG KONG  
ASIA'S HUB FOR CLIMATE ACTION & SUSTAINABLE BUSINESS SOLUTIONS

## Perspective View

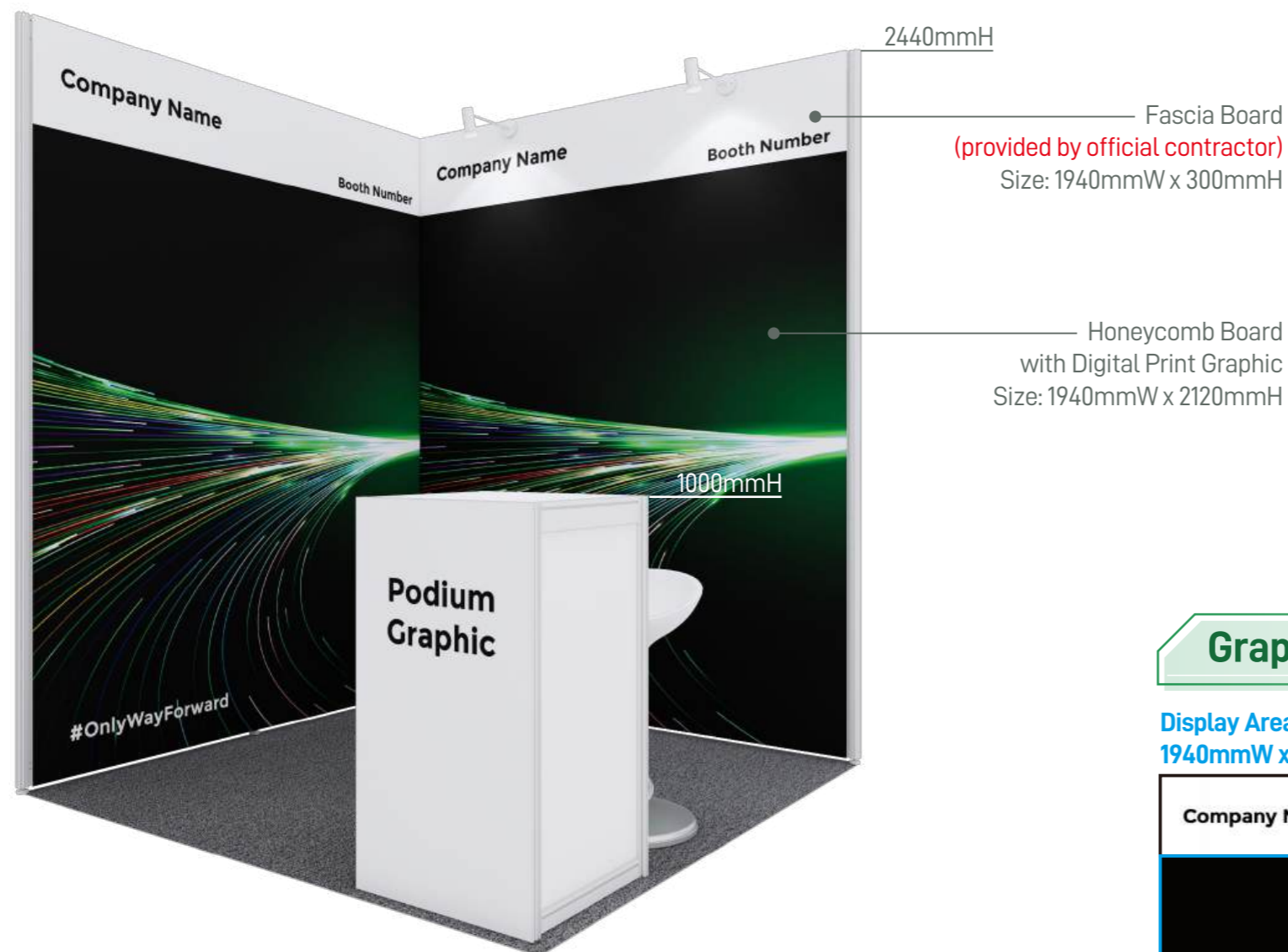

## Layout plan

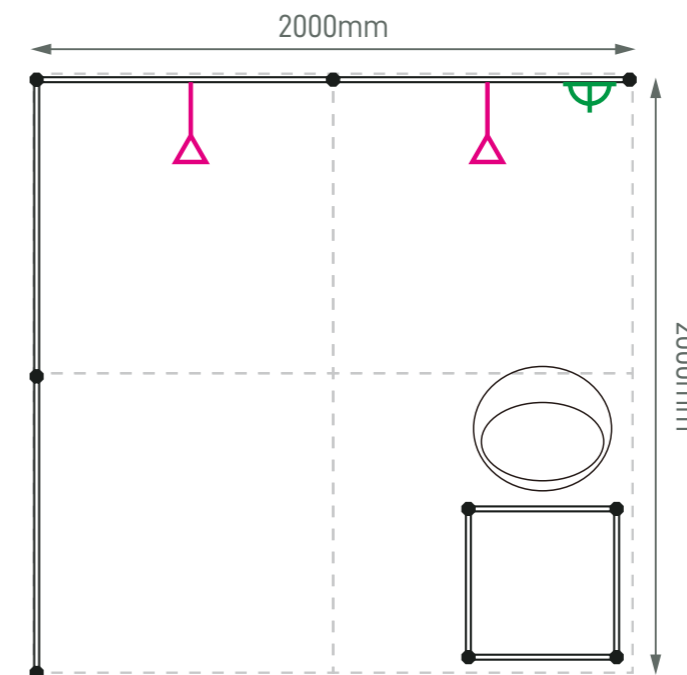

## Graphic Submission

Display Area / Graphic Size:  
1940mmW x 2120mmH

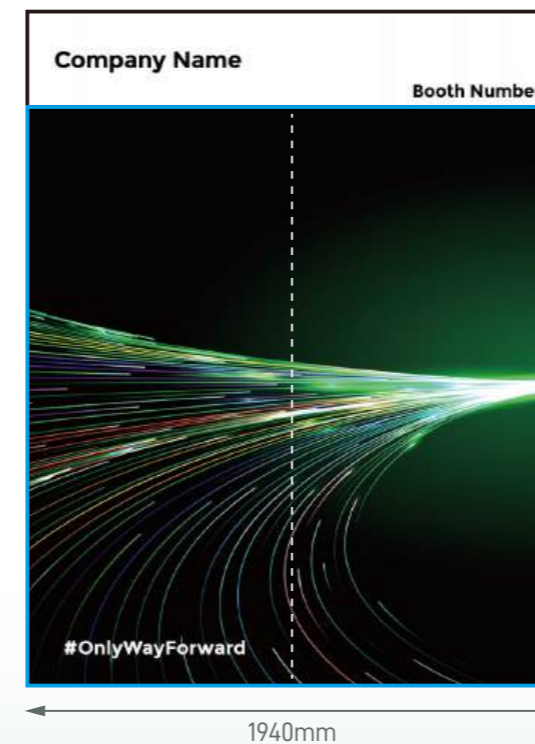

Display Area / Graphic Size:  
1940mmW x 2120mmH

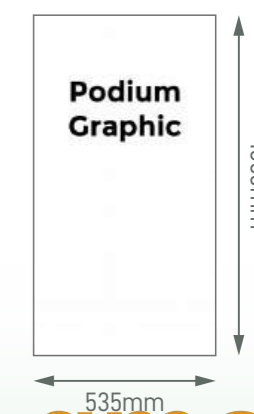
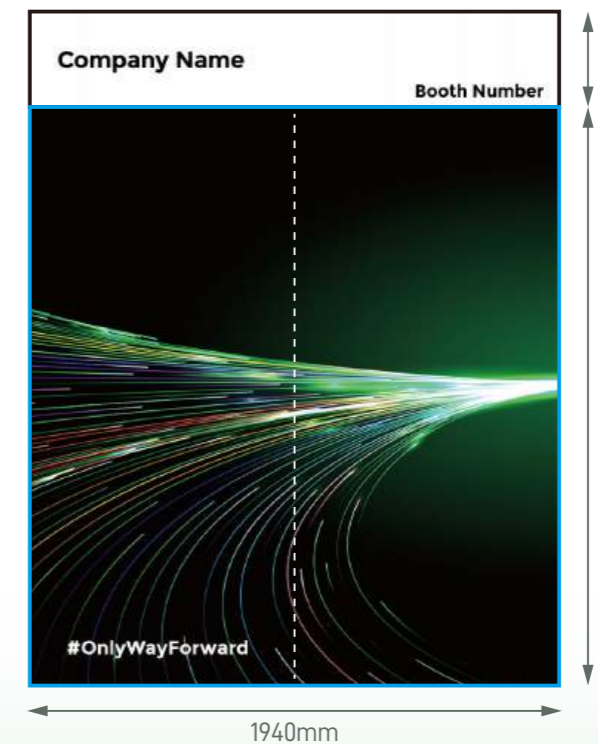

### Legend

	Qty
	2
	1
	1
	1

Revised Date: 27 May 2026 (V05)

# Standard Booth (B1) - 3m x 2m

Size: 3000mmL x 2000mmD x 2440mmH



10-11 SEPTEMBER 2026 | HONG KONG  
ASIA'S HUB FOR CLIMATE ACTION & SUSTAINABLE BUSINESS SOLUTIONS

## Perspective View

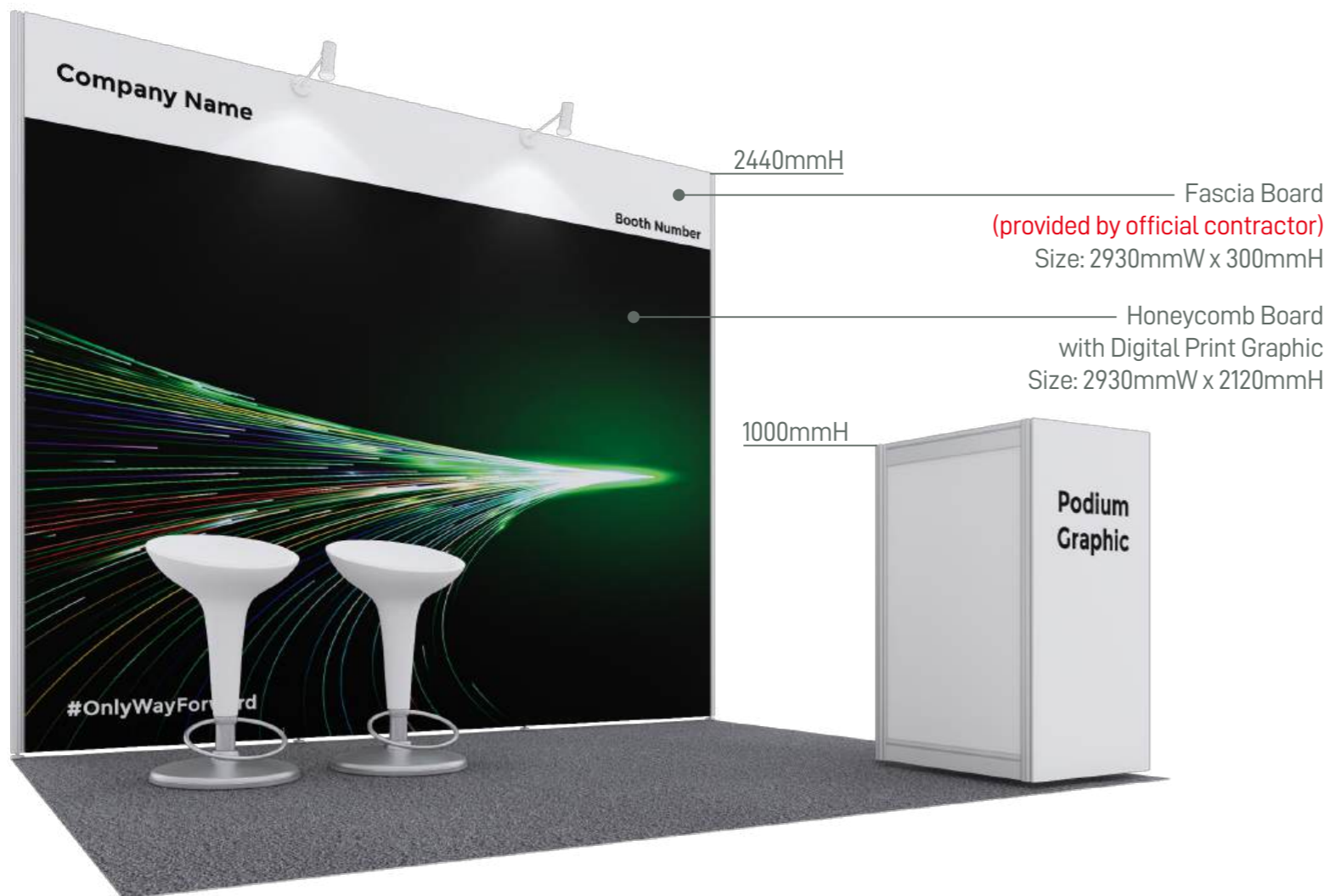

## Layout plan

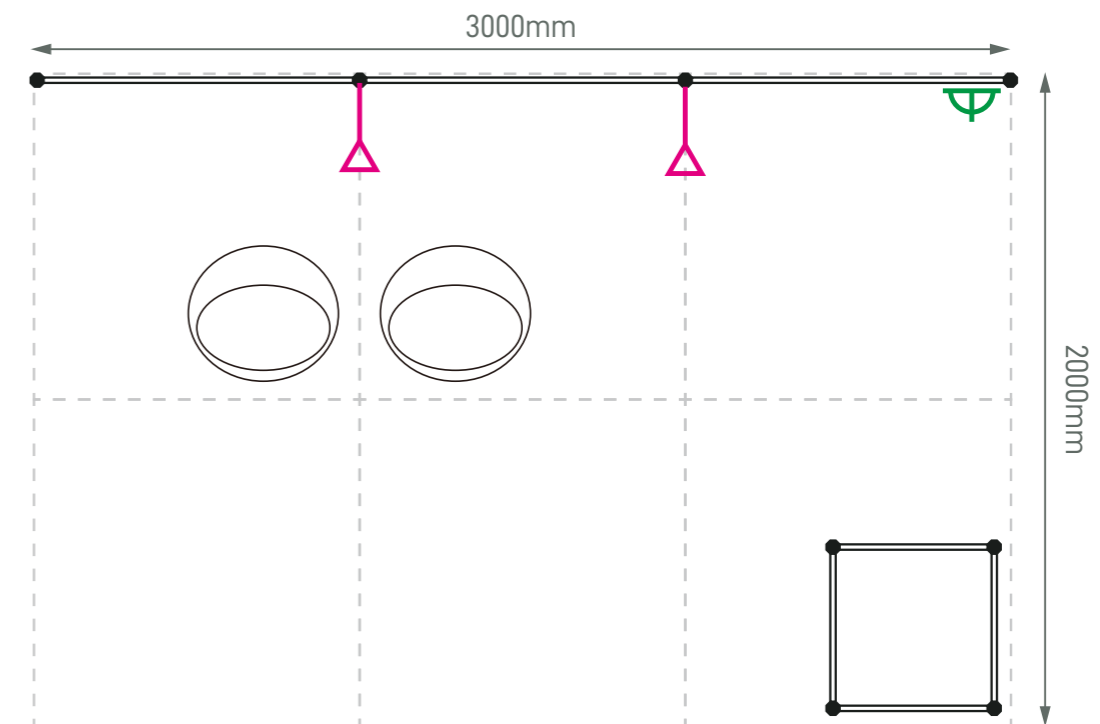

## Graphic Submission

Display Area / Graphic Size:  
2930mmW x 2120mmH

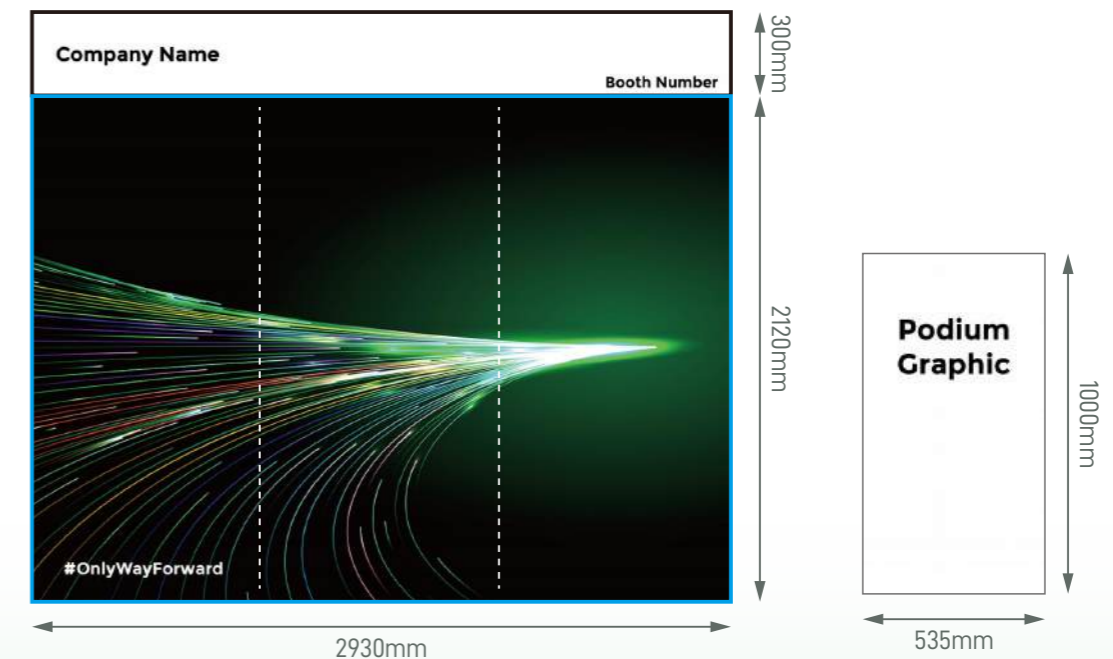

### Legend

	Qty
	2
	1
	1
	2

Revised Date: 27 May 2026 (V05)

# Standard Booth (B2L) - 3m x 2m

Size: 3000mmL x 2000mmD x 2440mmH

( Left opened )



10-11 SEPTEMBER 2026 | HONG KONG  
ASIA'S HUB FOR CLIMATE ACTION & SUSTAINABLE BUSINESS SOLUTIONS

## Perspective View

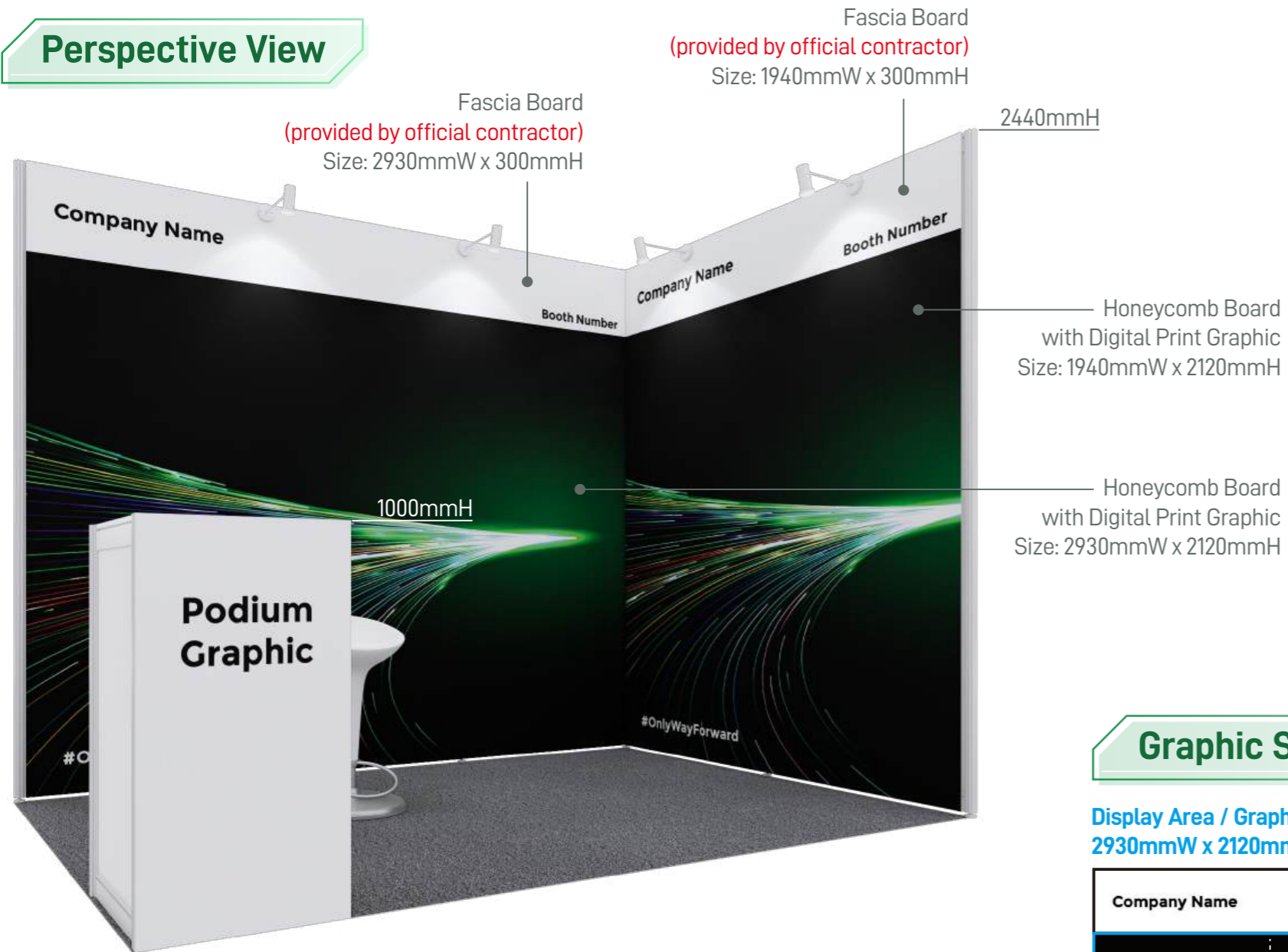

## Layout plan

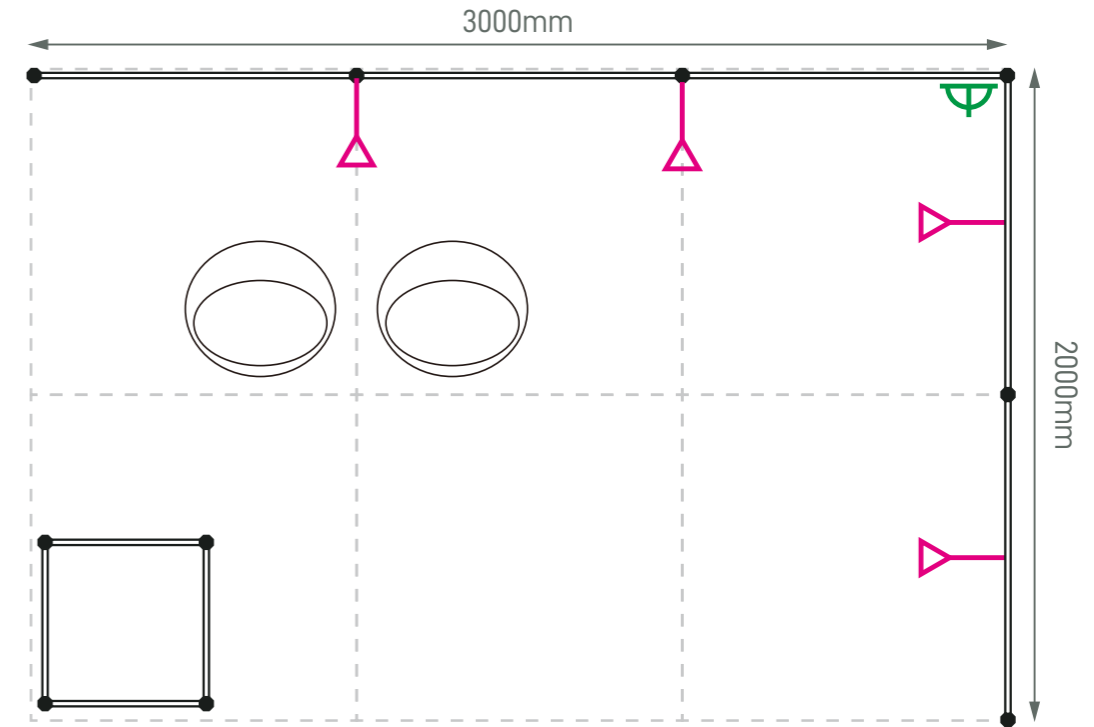

## Graphic Submission

Display Area / Graphic Size:  
2930mmW x 2120mmH

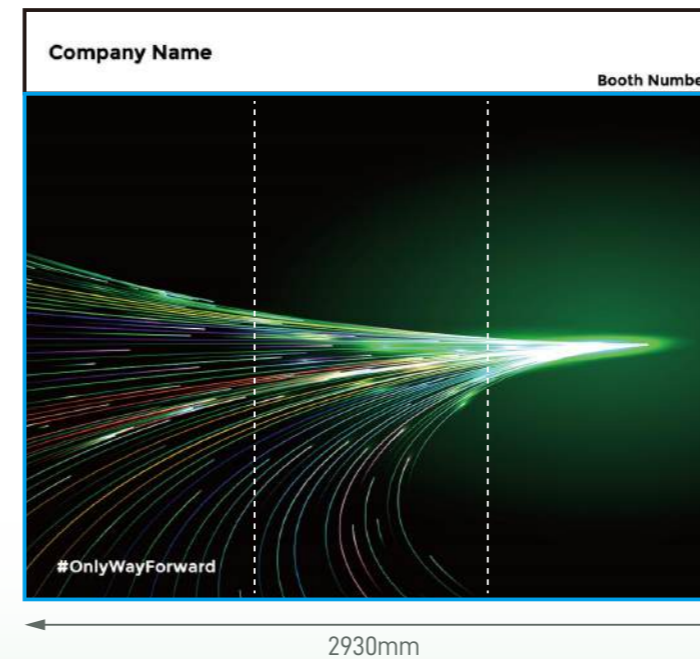

Display Area / Graphic Size:  
1940mmW x 2120mmH

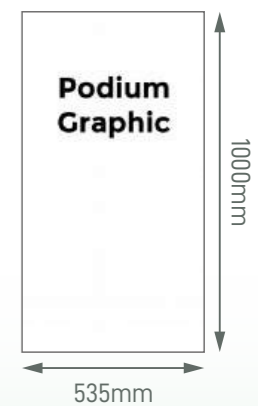
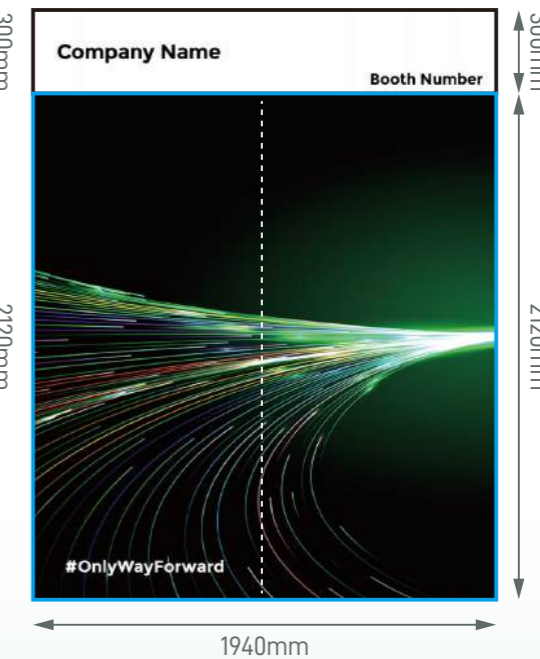

### Legend

	Qty
	4
	1
	1
	2

Revised Date: 27 May 2026 (V05)

The drawing is the property of AMC (Exhibits) Ltd and we reserve the copyright to all our designs which cannot be reproduced (whether part / whole or modified) without first obtaining our written consent. Contravention will be prosecuted. The drawing is subjected to modification of its design & measurement from time to time to suit construction purpose.

**amc**  
AMC (Exhibits) Ltd  
建同展覽有限公司

# Standard Booth (B2R) - 3m x 2m

Size: 3000mmL x 2000mmD x 2440mmH

( Right opened )



10-11 SEPTEMBER 2026 | HONG KONG  
ASIA'S HUB FOR CLIMATE ACTION & SUSTAINABLE BUSINESS SOLUTIONS

## Perspective View

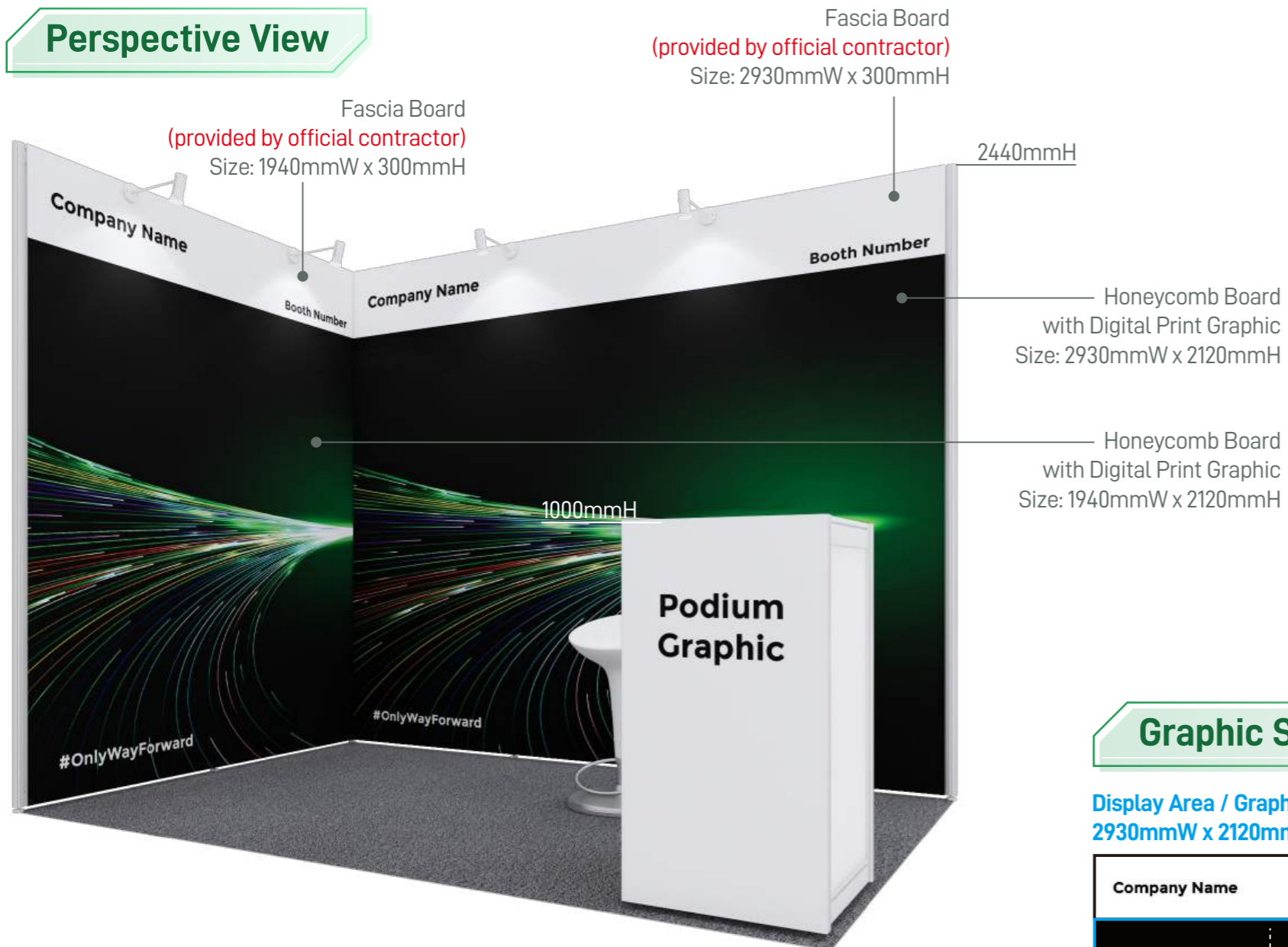

## Layout plan

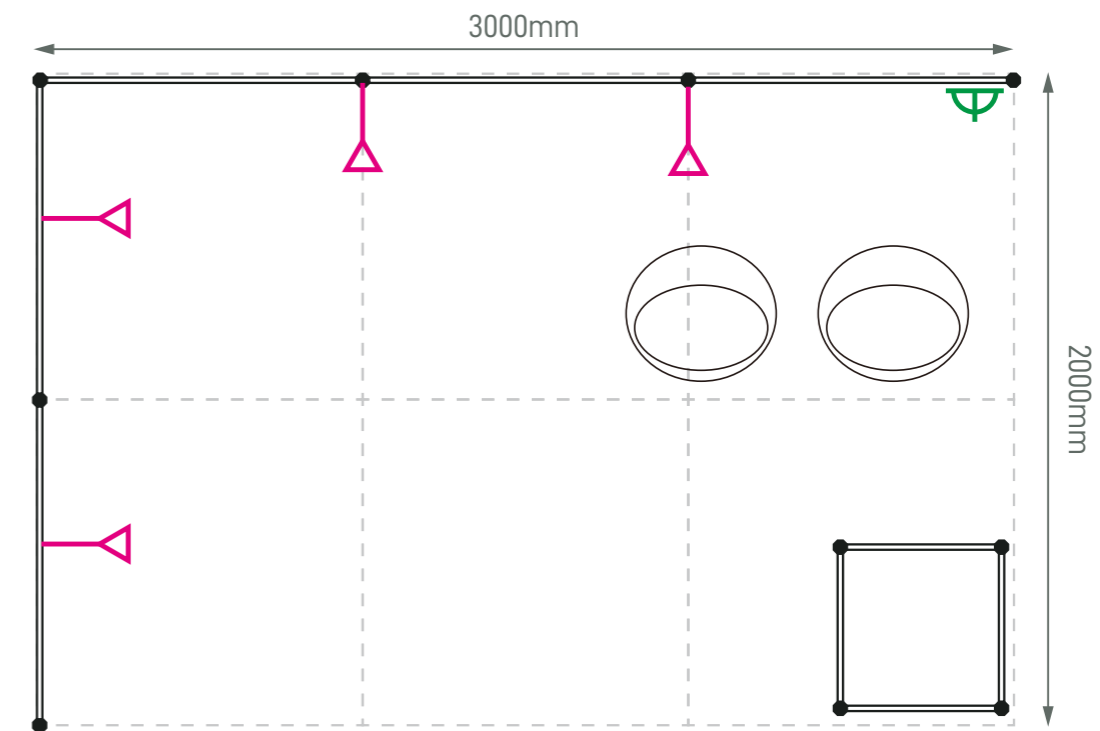

## Graphic Submission

Display Area / Graphic Size:  
2930mmW x 2120mmH

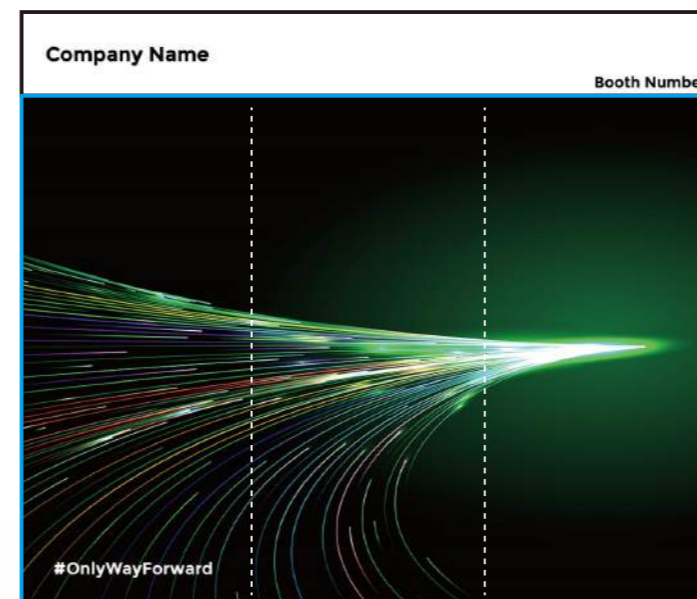

Display Area / Graphic Size:  
1940mmW x 2120mmH

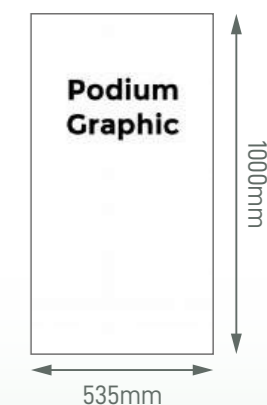
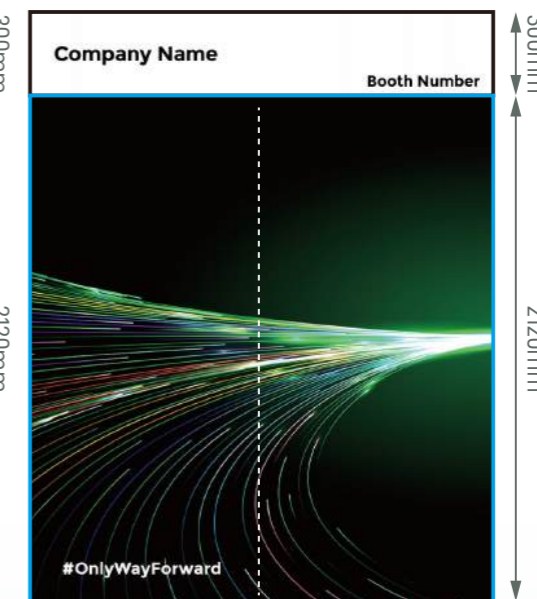

### Legend

	Qty
	4
	1
	1
	2

Revised Date: 27 May 2026 (V05)

# Standard Booth (B3) - 6m x 1m

Size: 6000mmL x 1000mmD x 2440mmH



10-11 SEPTEMBER 2026 | HONG KONG  
ASIA'S HUB FOR CLIMATE ACTION & SUSTAINABLE BUSINESS SOLUTIONS

## Perspective View



## Layout plan

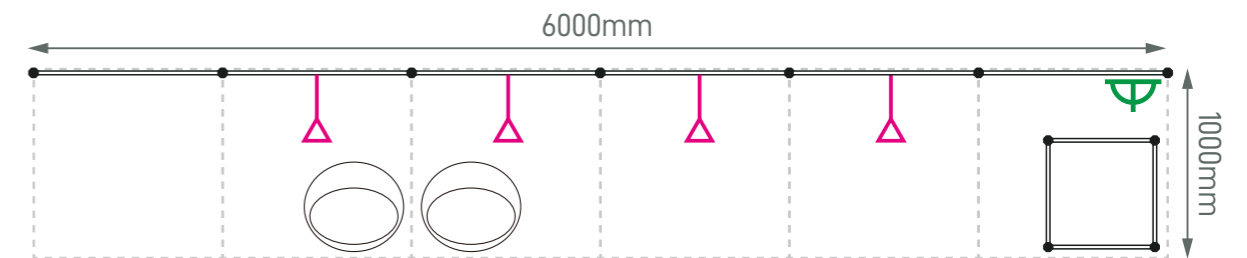

## Graphic Submission

Display Area / Graphic Size:  
5900mmW x 2120mmH

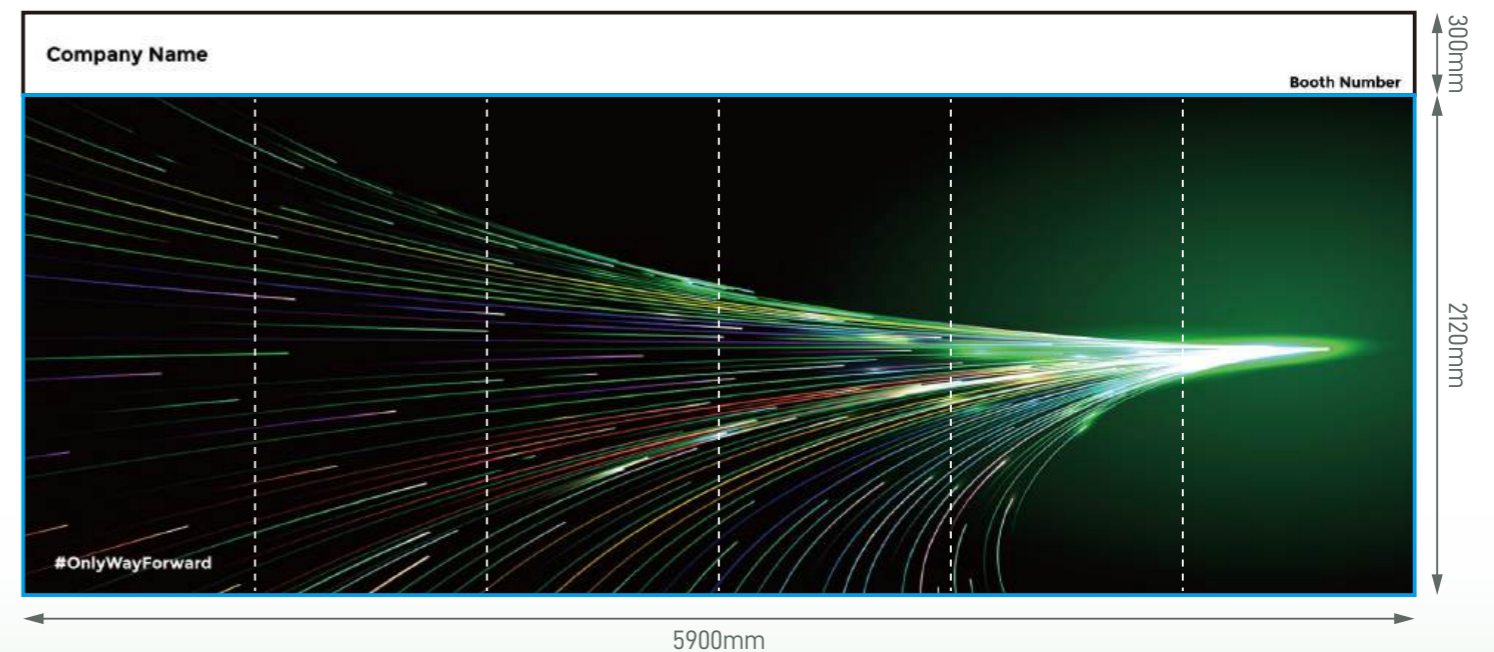
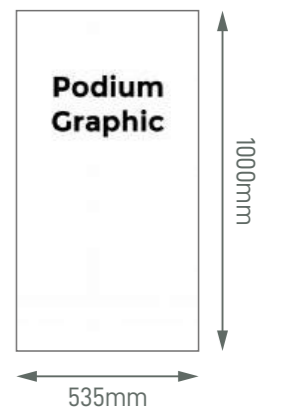

### Legend

	Qty
	4
	1
	1
	2

Revised Date: 27 May 2026 (V05)

The drawing is the property of AMC (Exhibits) Ltd and we reserve the copyright to all our designs which cannot be reproduced (whether part / whole or modified) without first obtaining our written consent. Contravention will be prosecuted. The drawing is subjected to modification of its design & measurement from time to time to suit construction purpose.

# Standard Booth (C1) - 4m x 2m

Size: 4000mmL x 2000mmD x 2440mmH



10-11 SEPTEMBER 2026 | HONG KONG  
ASIA'S HUB FOR CLIMATE ACTION & SUSTAINABLE BUSINESS SOLUTIONS

## Perspective View

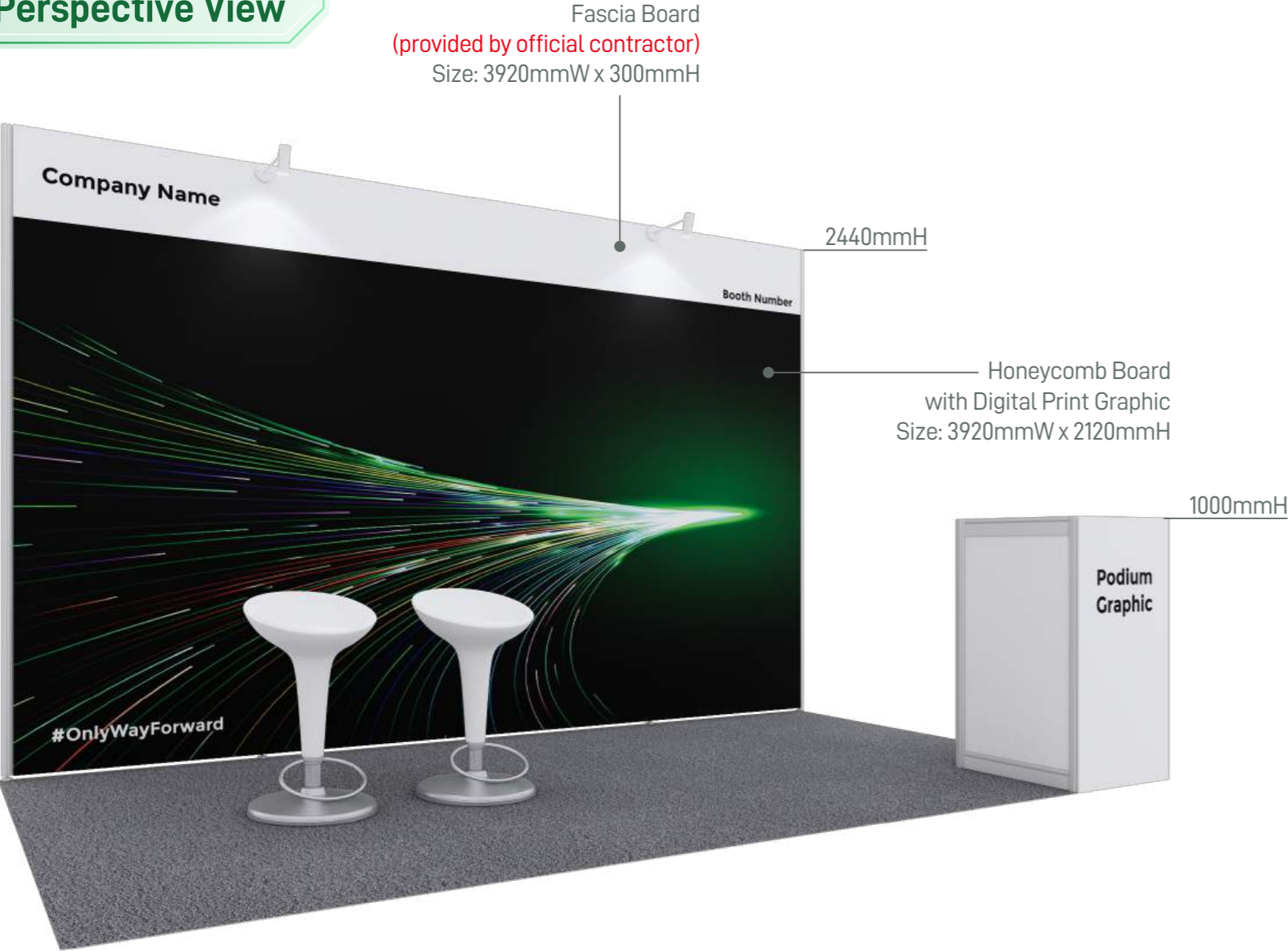

## Layout plan

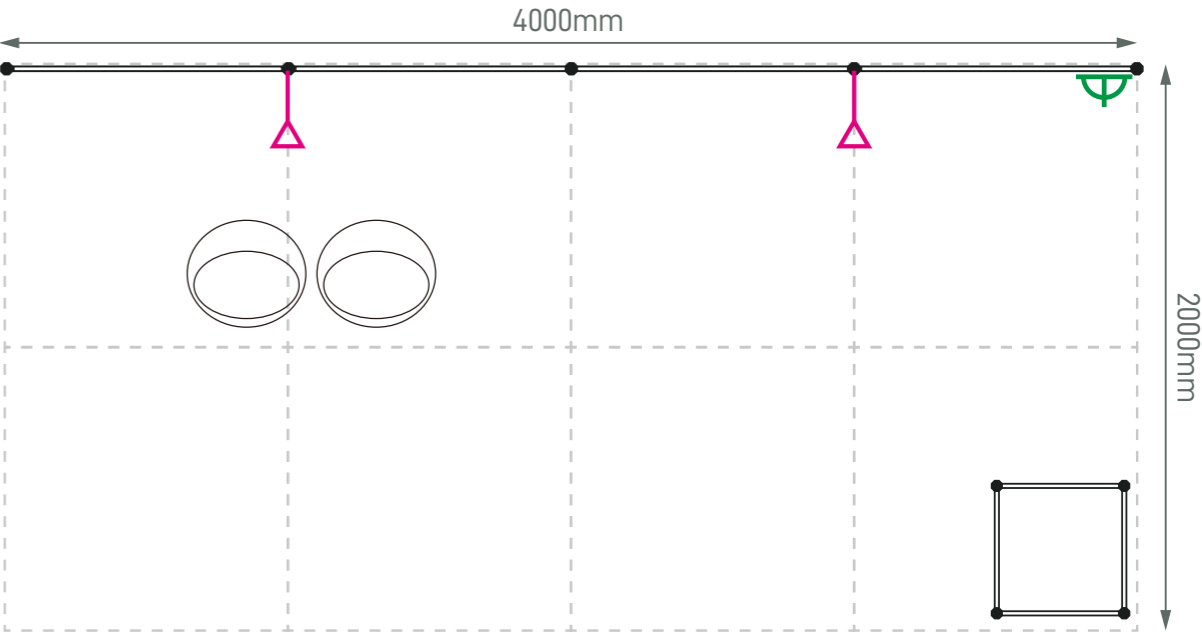

## Graphic Submission

Display Area / Graphic Size:  
3920mmW x 2120mmH

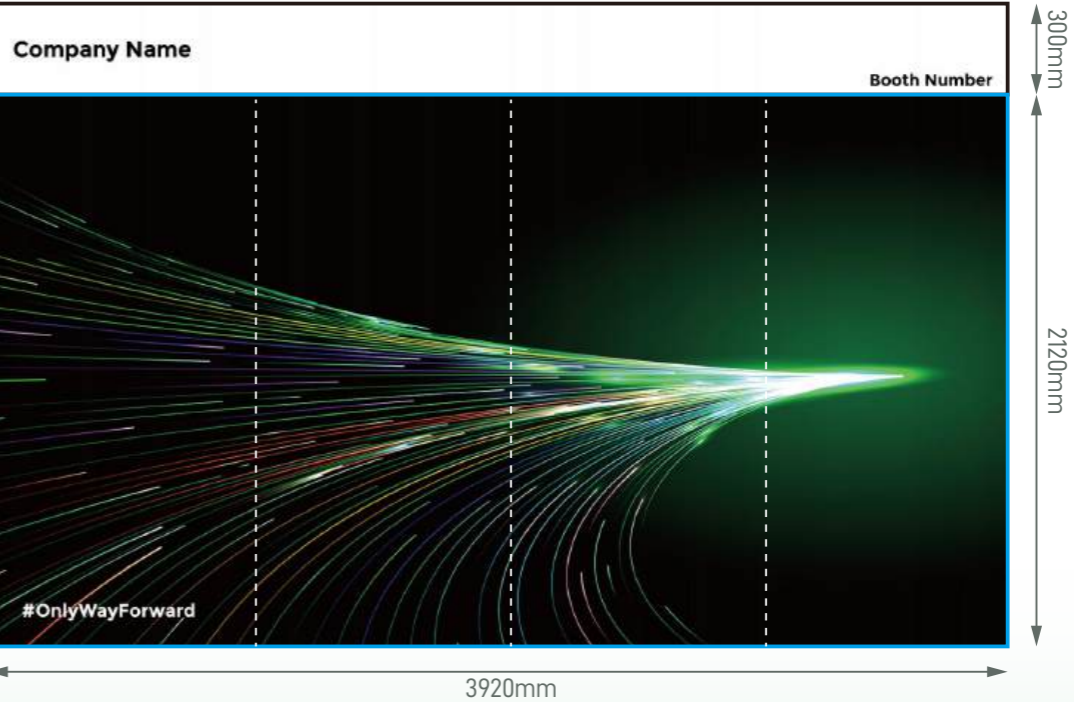

Legend	Qty
LED Longarm Spotlight	2
500W Square Pin Socket	1
Podium (0.5mW x 0.5mD x 1mH)	1
White Bar Stool	2

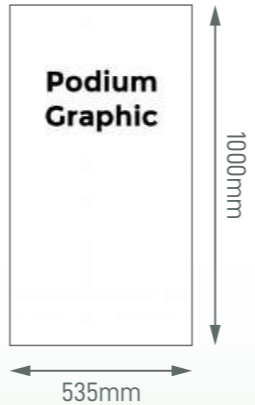

Revised Date: 27 May 2026 (V05)

The drawing is the property of AMC (Exhibits) Ltd and we reserve the copyright to all our designs which cannot be reproduced (whether part / whole or modified) without first obtaining our written consent. Contravention will be prosecuted. The drawing is subjected to modification of its design & measurement from time to time to suit construction purpose.



# Standard Booth (C2L) - 4m x 2m

Size: 4000mmL x 2000mmD x 2440mmH

( Left opened )



10-11 SEPTEMBER 2026 | HONG KONG  
ASIA'S HUB FOR CLIMATE ACTION & SUSTAINABLE BUSINESS SOLUTIONS

## Perspective View

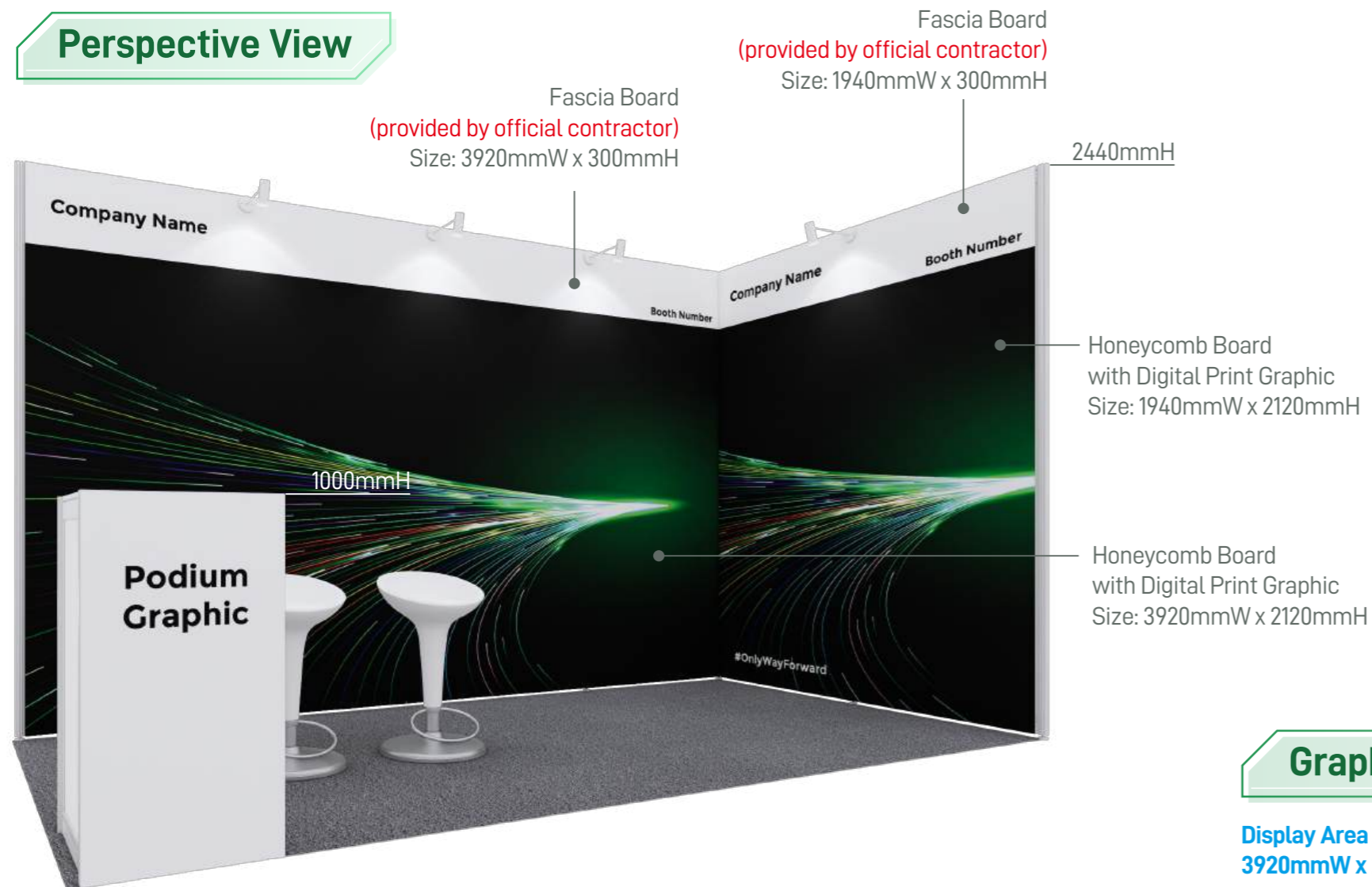

## Layout plan

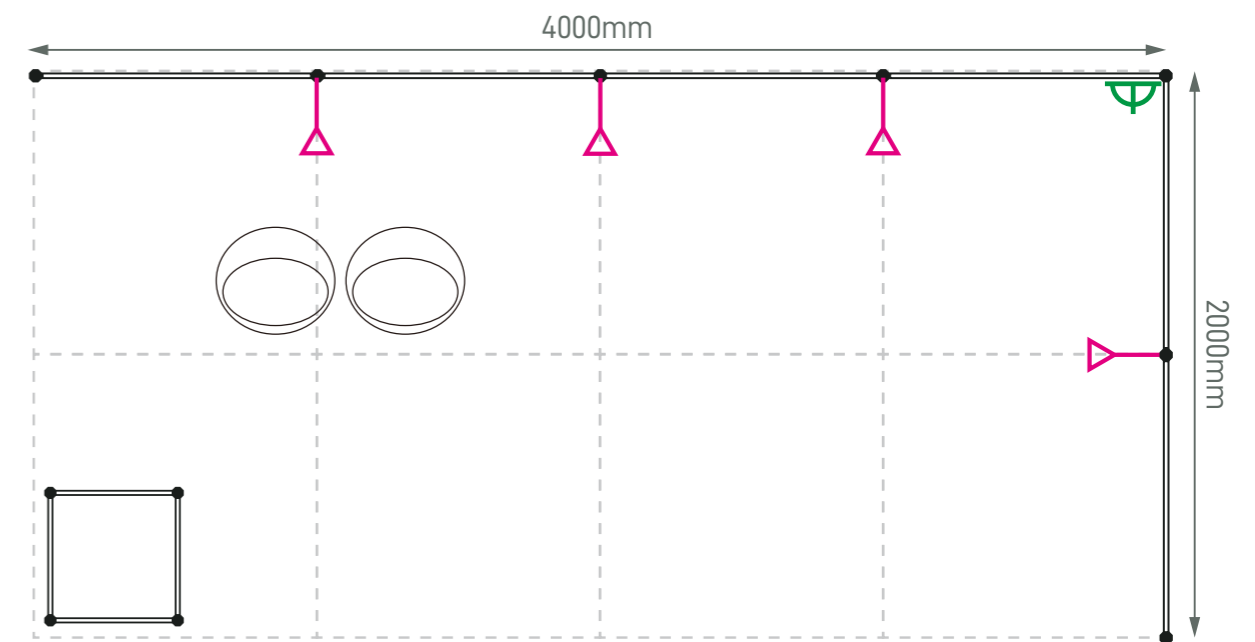

## Graphic Submission

Display Area / Graphic Size:  
3920mmW x 2120mmH

Display Area / Graphic Size:  
1940mmW x 2120mmH

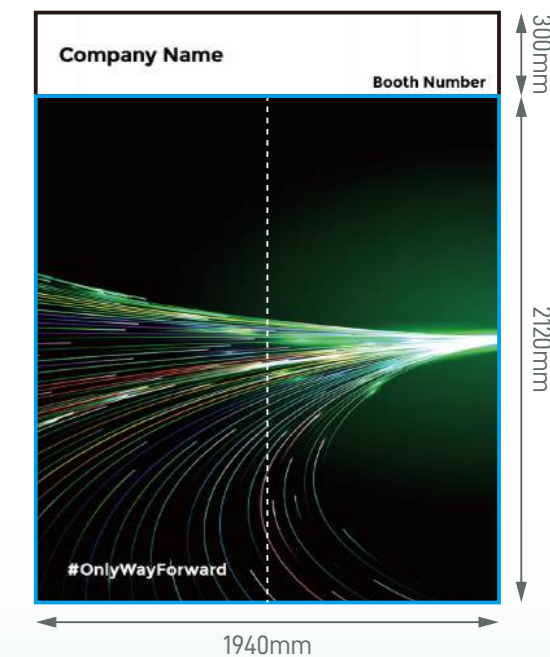
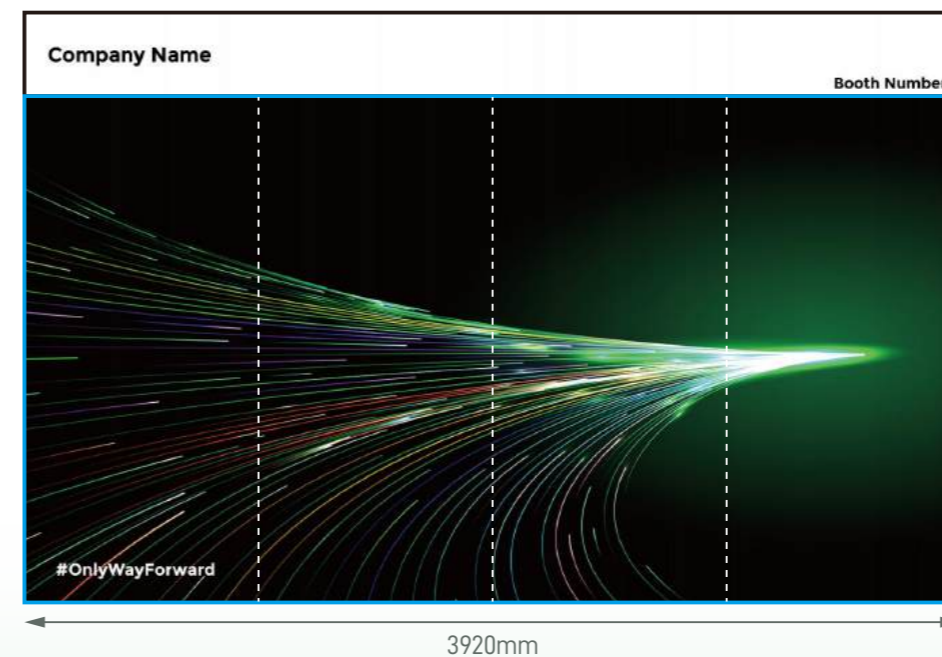

### Legend

Legend	Qty
LED Longarm Spotlight	4
500W Square Pin Socket	1
Podium (0.5mW x 0.5mD x 1mH)	1
White Bar Stool	2

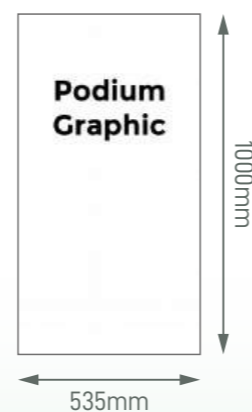

Revised Date: 27 May 2026 (V05)

# Standard Booth (C2R) - 4m x 2m

Size: 4000mmL x 2000mmD x 2440mmH

( Right opened )



10-11 SEPTEMBER 2026 | HONG KONG  
ASIA'S HUB FOR CLIMATE ACTION & SUSTAINABLE BUSINESS SOLUTIONS

## Perspective View

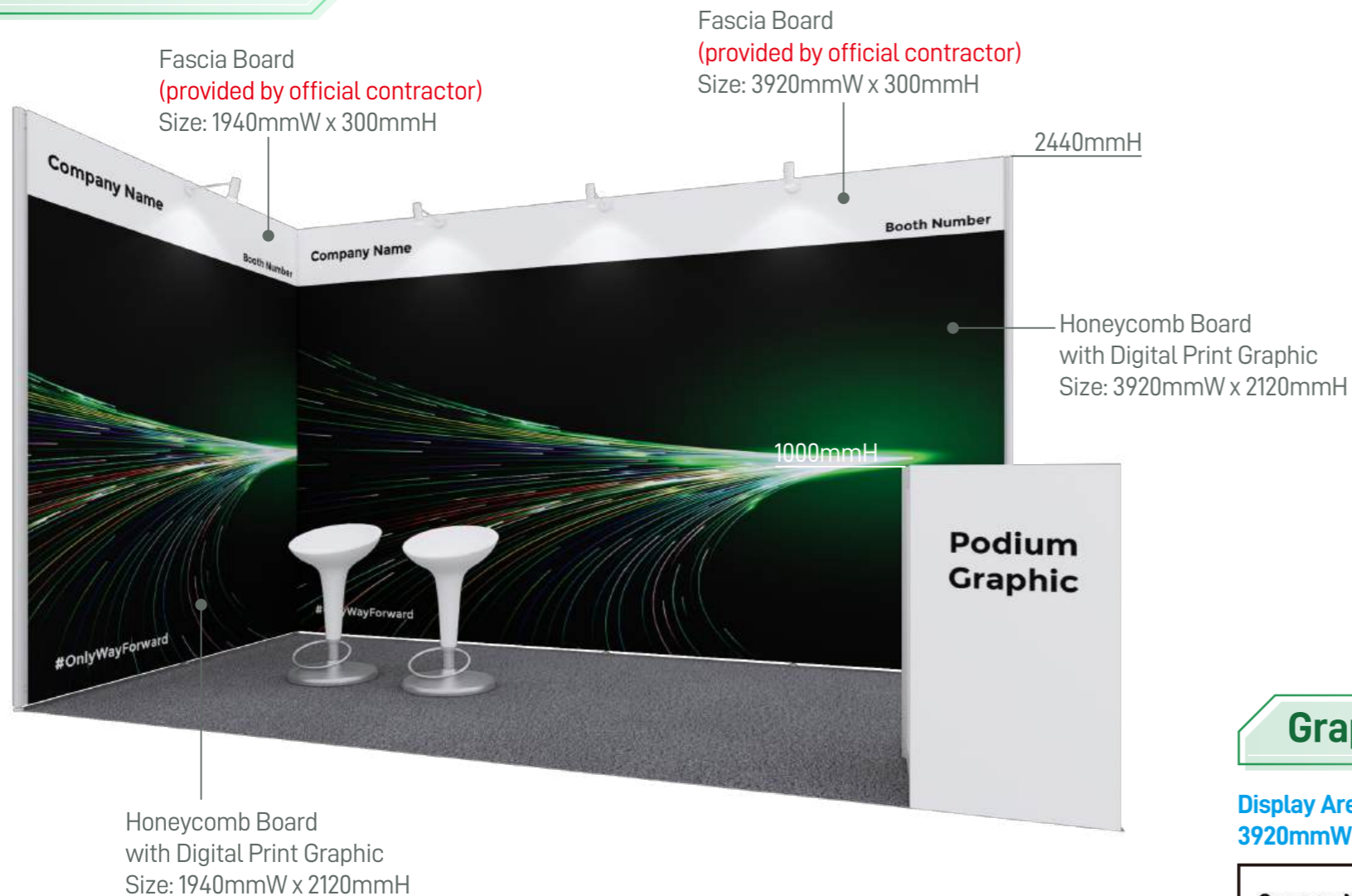

## Layout plan

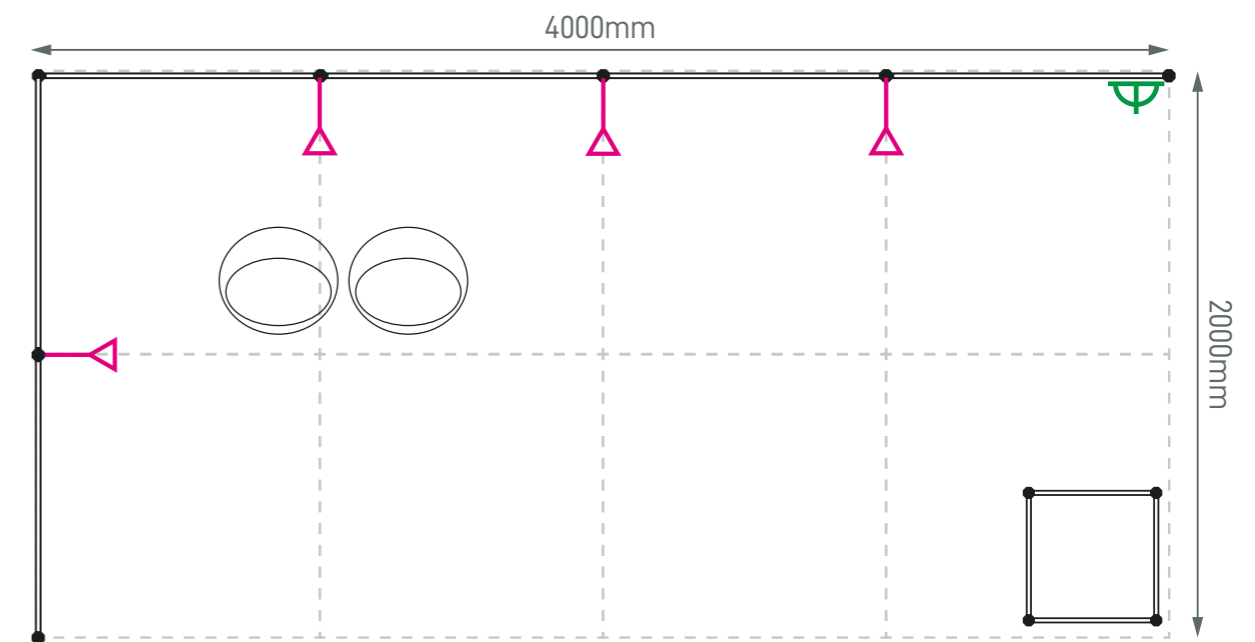

## Graphic Submission

Display Area / Graphic Size:  
3920mmW x 2120mmH

Display Area / Graphic Size:  
1940mmW x 2120mmH

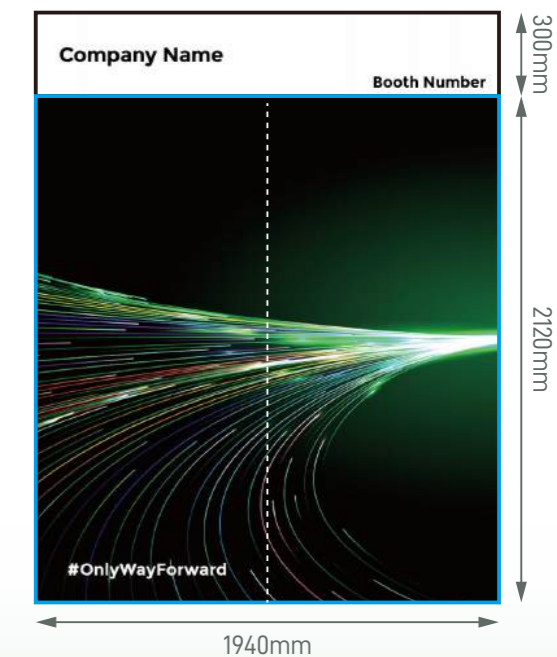
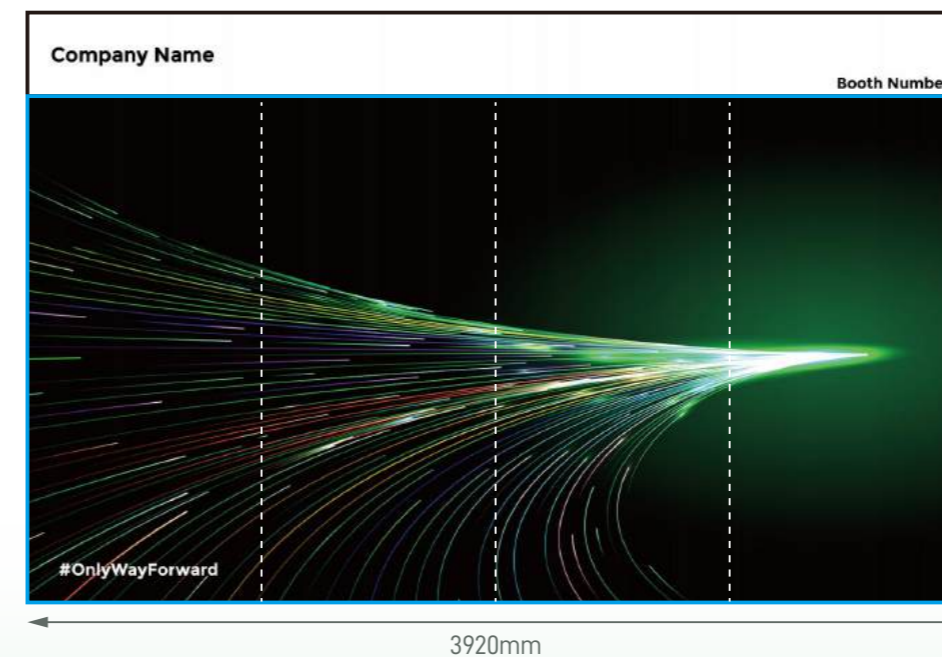

### Legend

	Qty
	4
	1
	1
	2

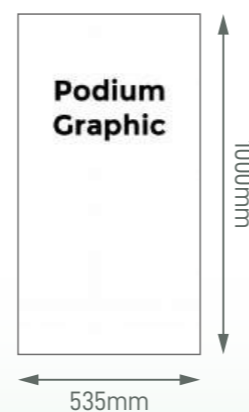

Revised Date: 27 May 2026 (V05)

The drawing is the property of AMC (Exhibits) Ltd and we reserve the copyright to all our designs which cannot be reproduced (whether part / whole or modified) without first obtaining our written consent. Contravention will be prosecuted. The drawing is subjected to modification of its design & measurement from time to time to suit construction purpose.

**amc**  
AMC (Exhibits) Ltd  
建同展覽有限公司

# Standard Booth (D) - 3m x 3m

Size: 3000mmL x 3000mmD x 2440mmH



10-11 SEPTEMBER 2026 | HONG KONG  
ASIA'S HUB FOR CLIMATE ACTION & SUSTAINABLE BUSINESS SOLUTIONS

## Perspective View

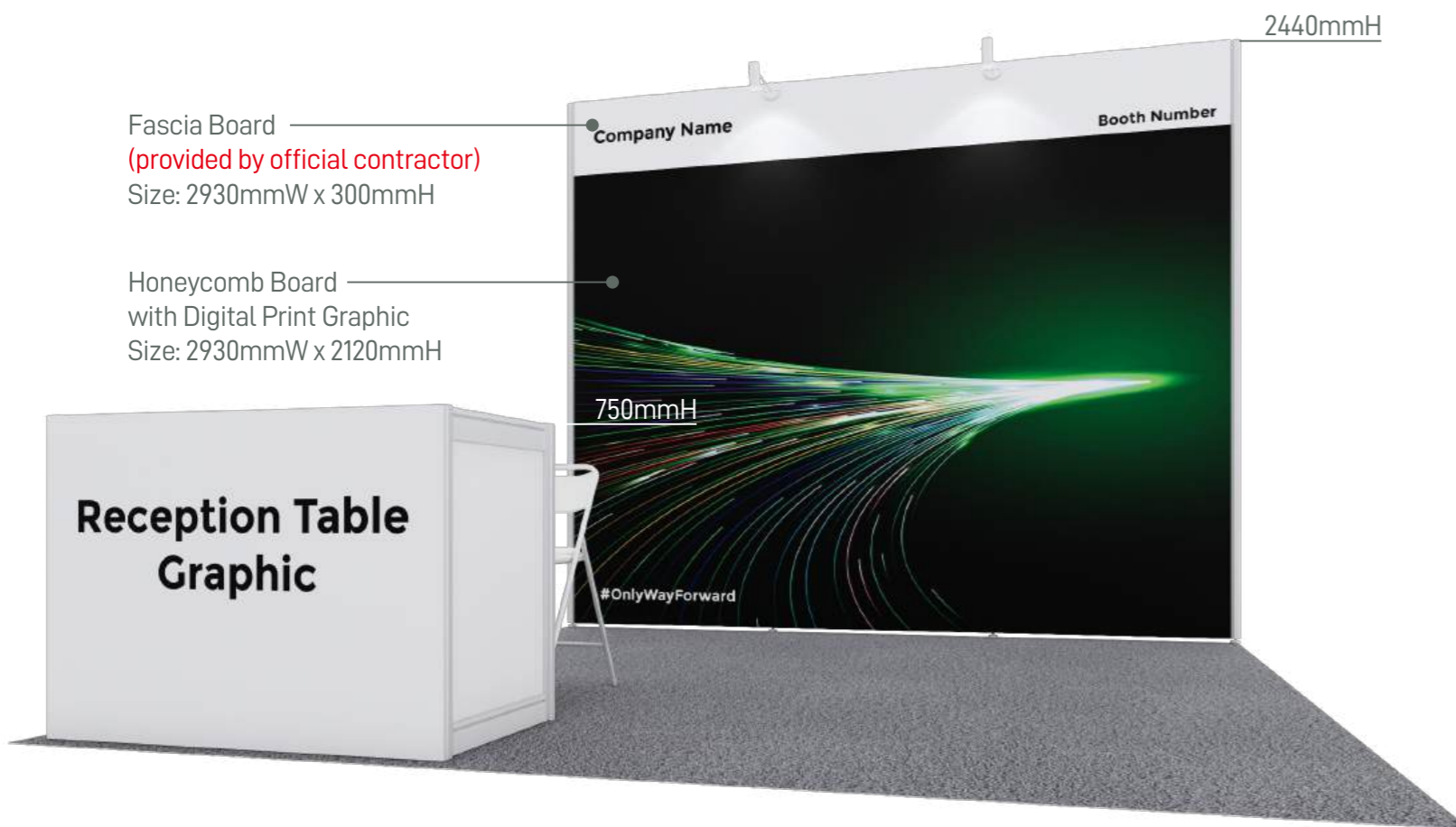

## Layout plan

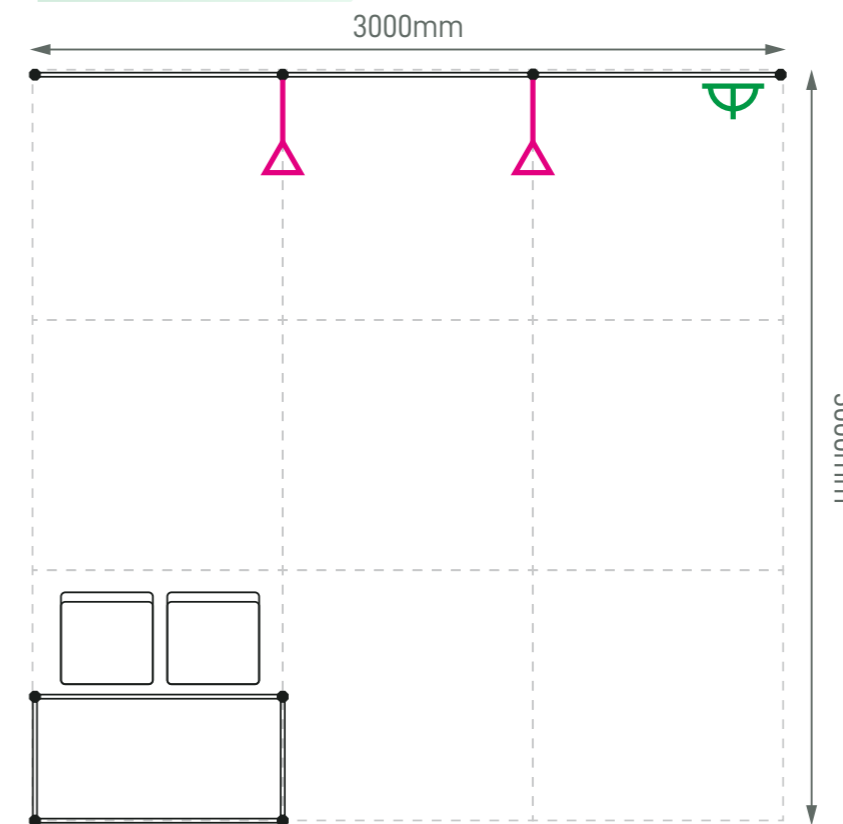

## Graphic Submission

Display Area / Graphic Size:  
2930mmW x 2120mmH

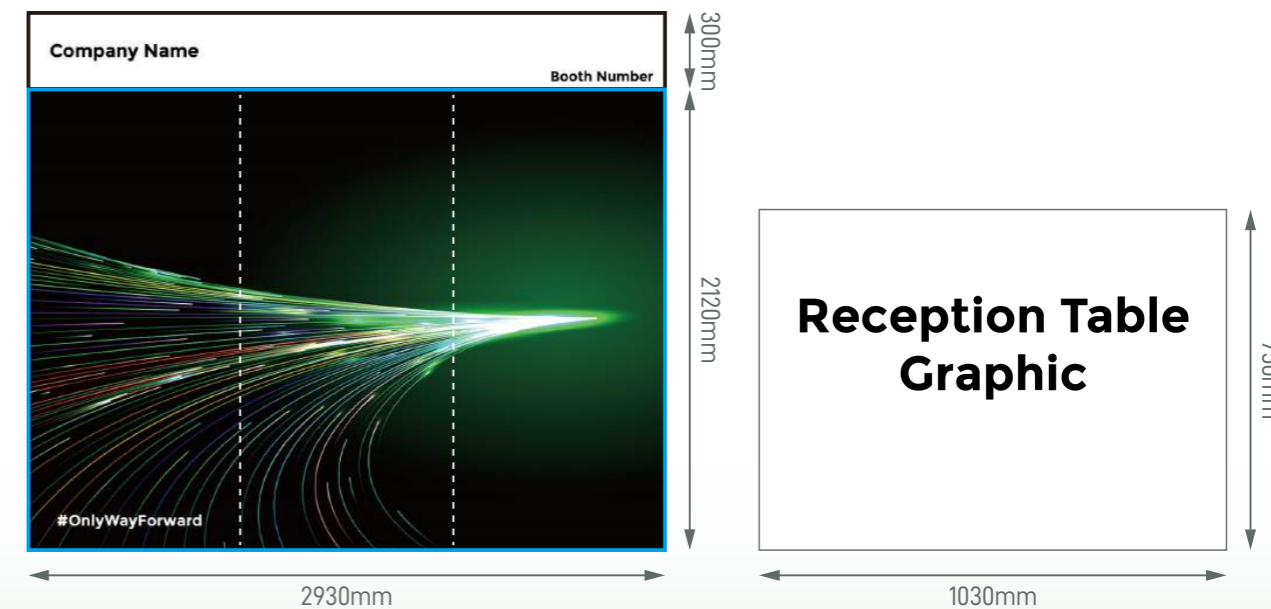

### Legend Qty

	LED Longarm Spotlight	2
	500W Square Pin Socket	1
	Reception Desk (1mW x 0.5mD x 0.75mH)	1
	Folding Chair	2

Revised Date: 27 May 2026 (V05)

# Standard Booth (D1L) - 3m x 3m

Size: 3000mmL x 3000mmD x 2440mmH

( Left opened )



10-11 SEPTEMBER 2026 | HONG KONG  
ASIA'S HUB FOR CLIMATE ACTION & SUSTAINABLE BUSINESS SOLUTIONS

## Perspective View

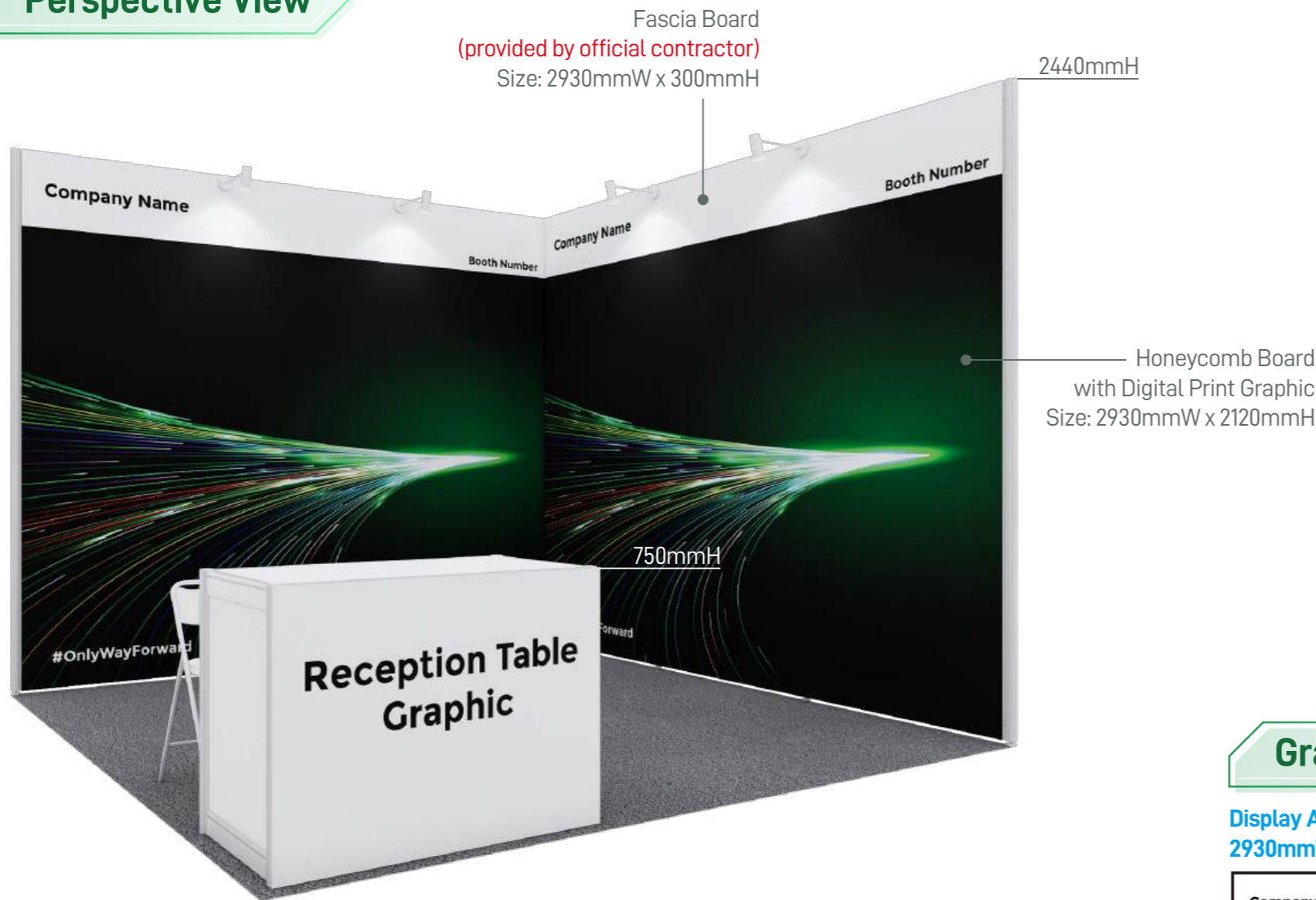

## Layout plan

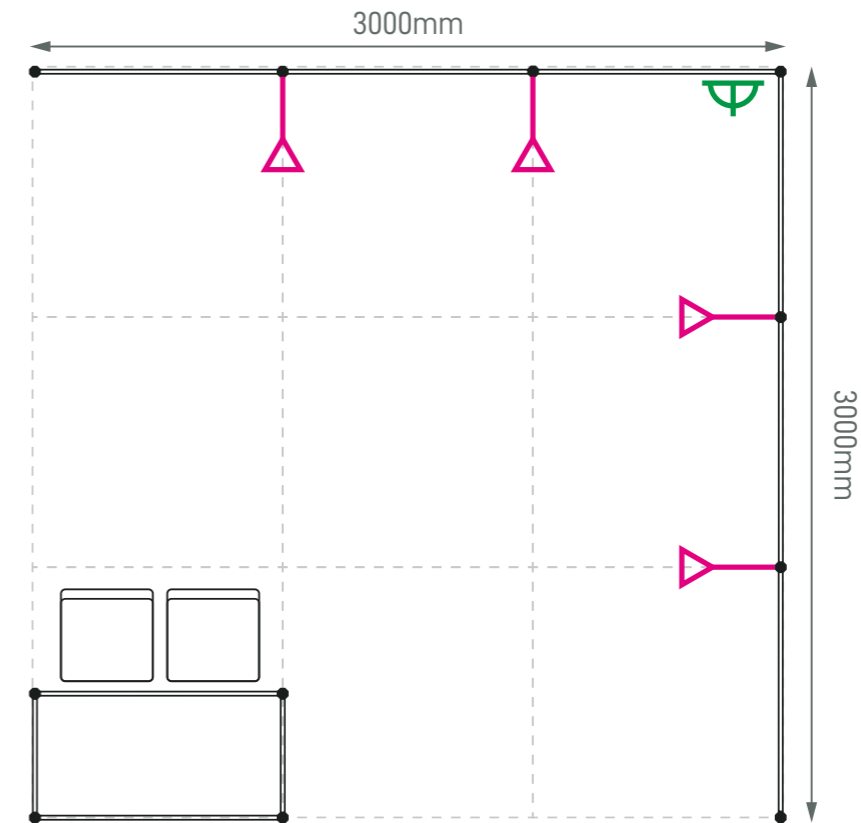

## Graphic Submission

Display Area / Graphic Size:  
2930mmW x 2120mmH

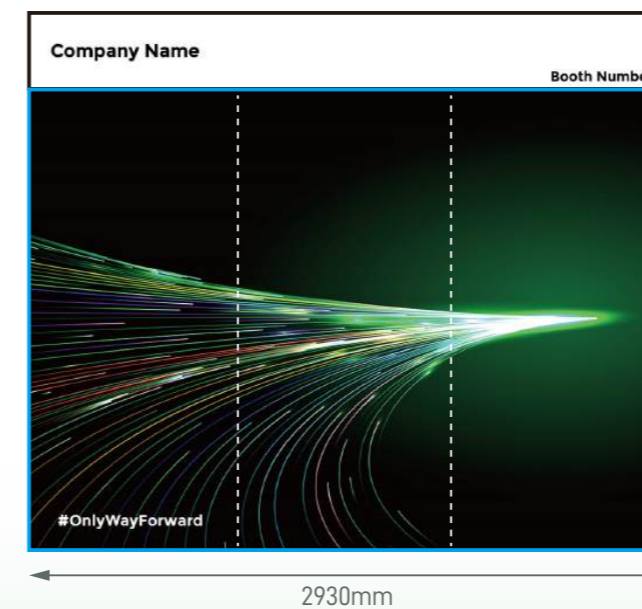

Display Area / Graphic Size:  
2930mmW x 2120mmH

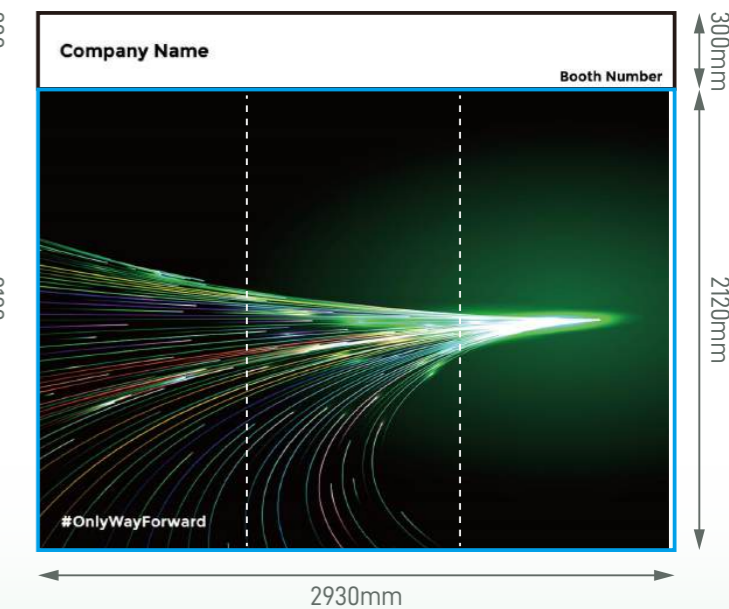

### Legend

	Qty
	4
	1
	1
	2



Revised Date: 27 May 2026 (V05)

# Standard Booth (D1R) - 3m x 3m

Size: 3000mmL x 3000mmD x 2440mmH

( Right opened )



10-11 SEPTEMBER 2026 | HONG KONG  
ASIA'S HUB FOR CLIMATE ACTION & SUSTAINABLE BUSINESS SOLUTIONS

## Perspective View

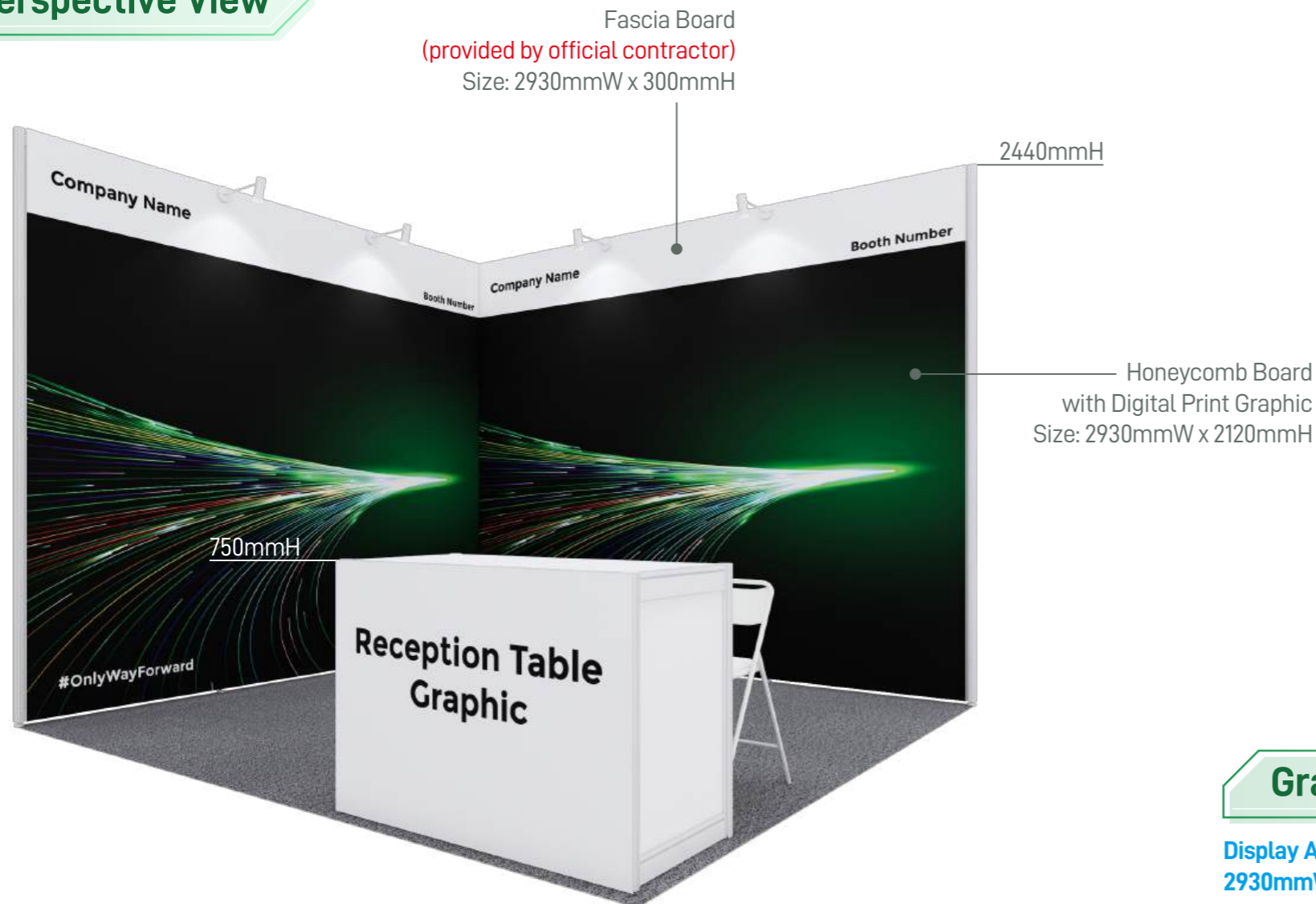

## Layout plan

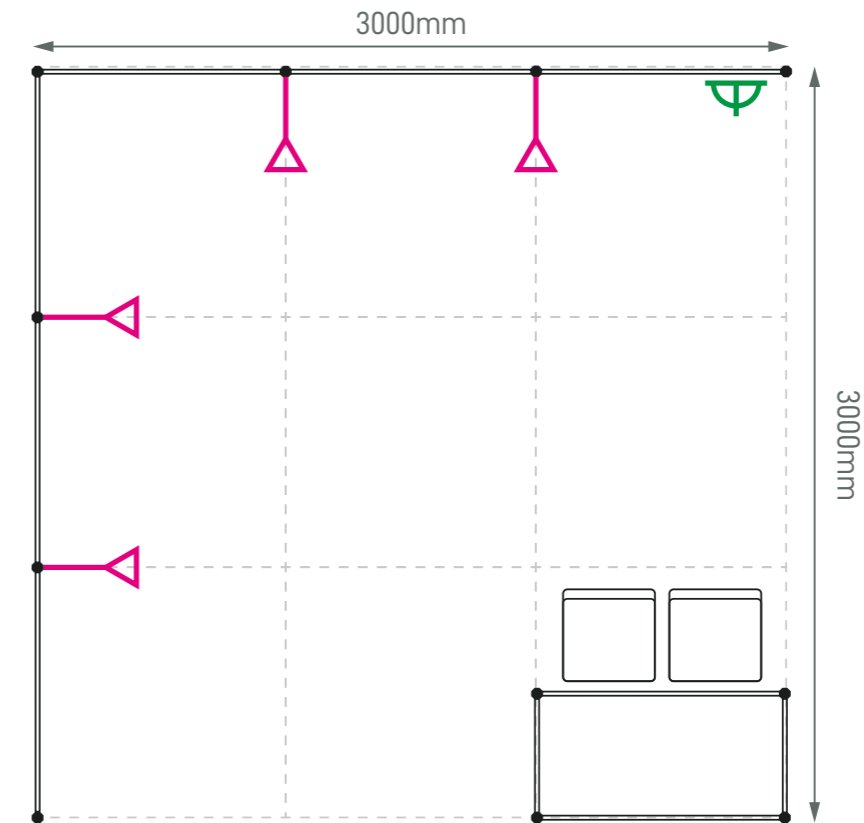

## Graphic Submission

Display Area / Graphic Size:  
2930mmW x 2120mmH

Display Area / Graphic Size:  
2930mmW x 2120mmH

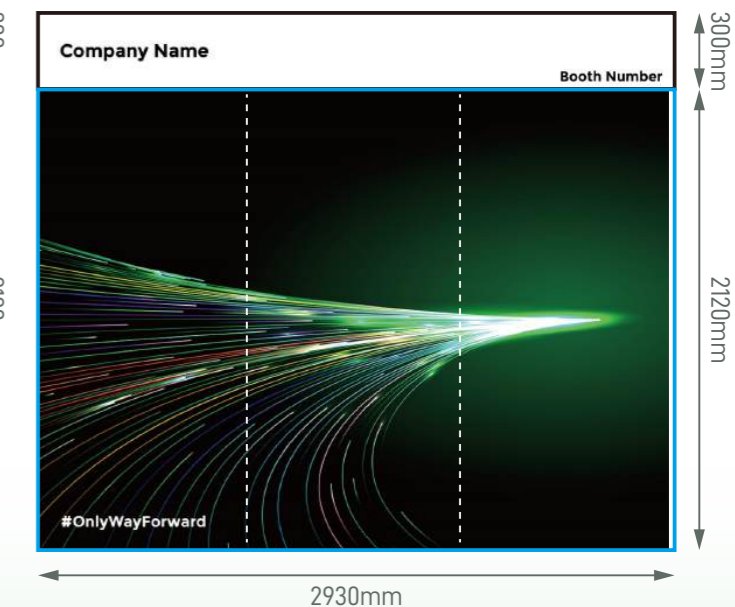
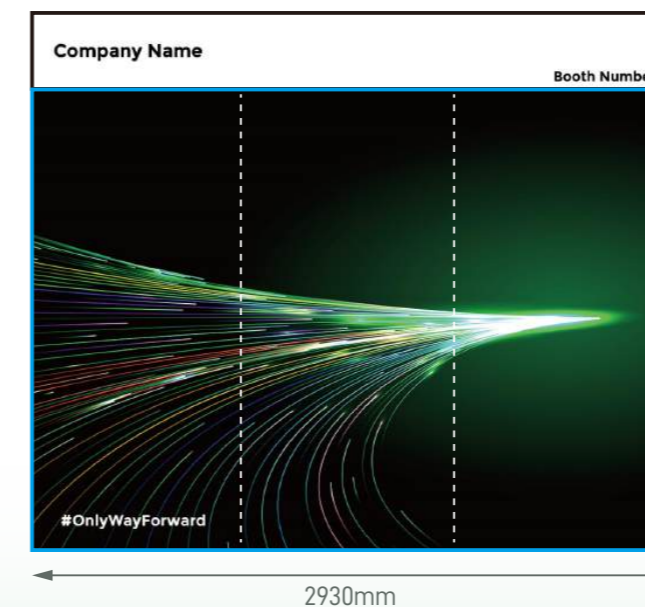

### Legend

	Qty
	4
	1
	1
	2

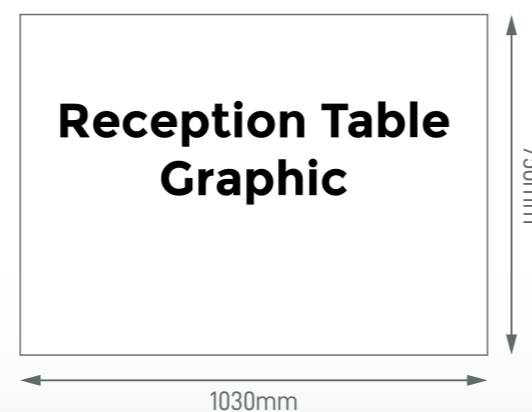

Revised Date: 27 May 2026 (V05)

The drawing is the property of AMC (Exhibits) Ltd and we reserve the copyright to all our designs which cannot be reproduced (whether part / whole or modified) without first obtaining our written consent. Contravention will be prosecuted. The drawing is subjected to modification of its design & measurement from time to time to suit construction purpose.

# Standard Booth (D2) - 3m x 3m

Size: 3000mmL x 3000mmD x 2440mmH



10-11 SEPTEMBER 2026 | HONG KONG  
ASIA'S HUB FOR CLIMATE ACTION & SUSTAINABLE BUSINESS SOLUTIONS

## Perspective View

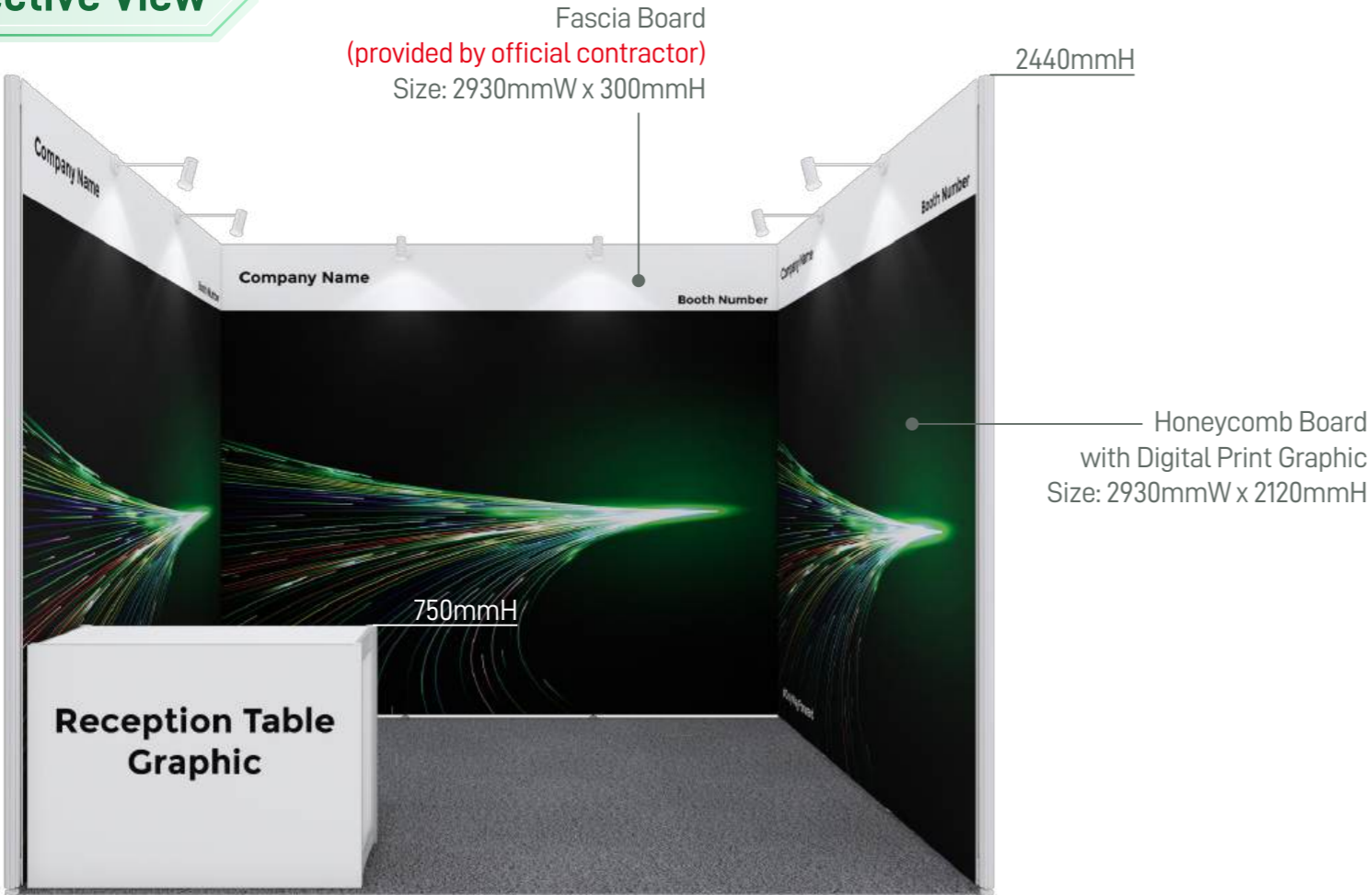

## Layout plan

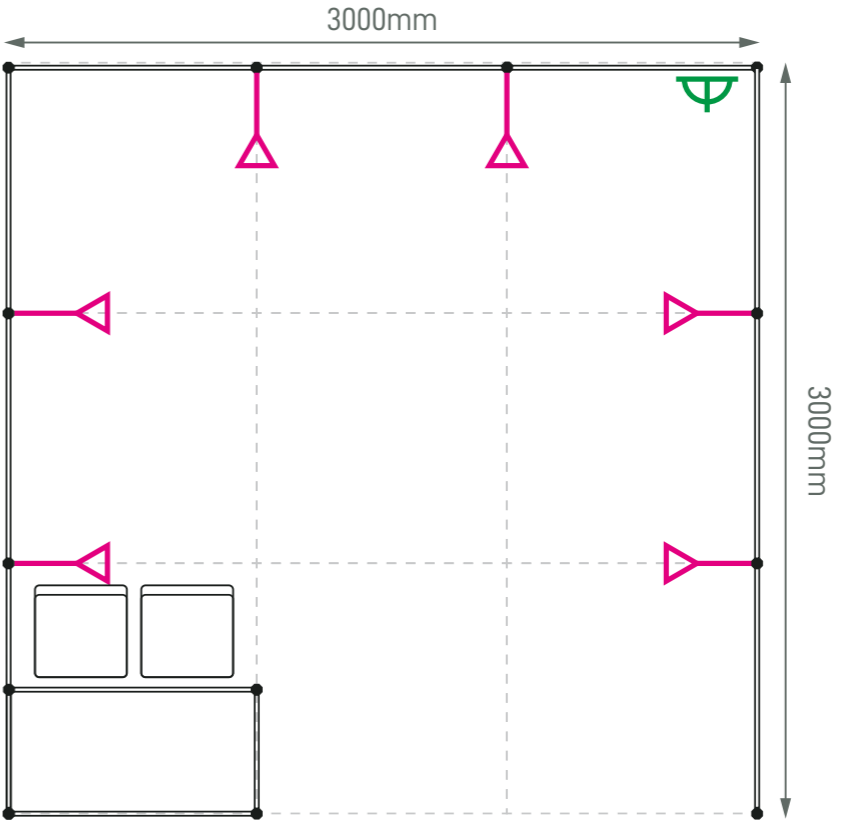

## Graphic Submission

Display Area / Graphic Size:  
2930mmW x 2120mmH

Display Area / Graphic Size:  
2930mmW x 2120mmH

Display Area / Graphic Size:  
2930mmW x 2120mmH

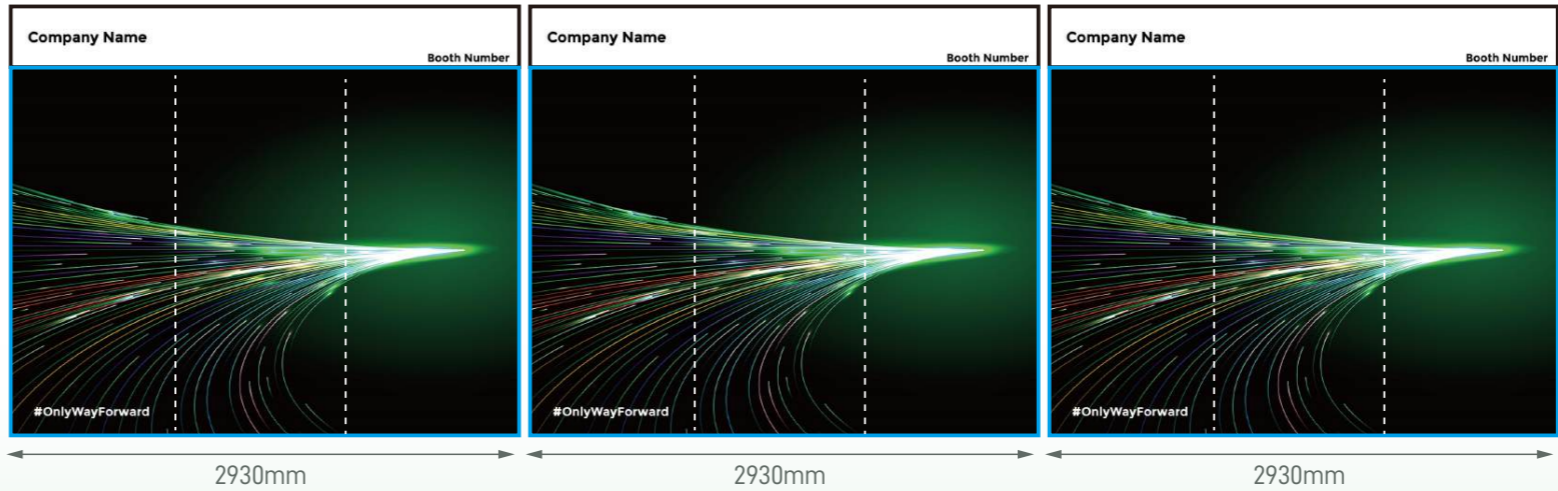

Legend	Qty
	LED Longarm Spotlight 6
	500W Square Pin Socket 1
	Reception Desk (1mW x 0.5mD x 0.75mH) 1
	Folding Chair 2

Revised Date: 27 May 2026 (V05)



# Standard Booth (E1) - 5m x 2m

Size: 5000mmL x 2000mmD x 2440mmH



10-11 SEPTEMBER 2026 | HONG KONG  
ASIA'S HUB FOR CLIMATE ACTION & SUSTAINABLE BUSINESS SOLUTIONS

## Perspective View

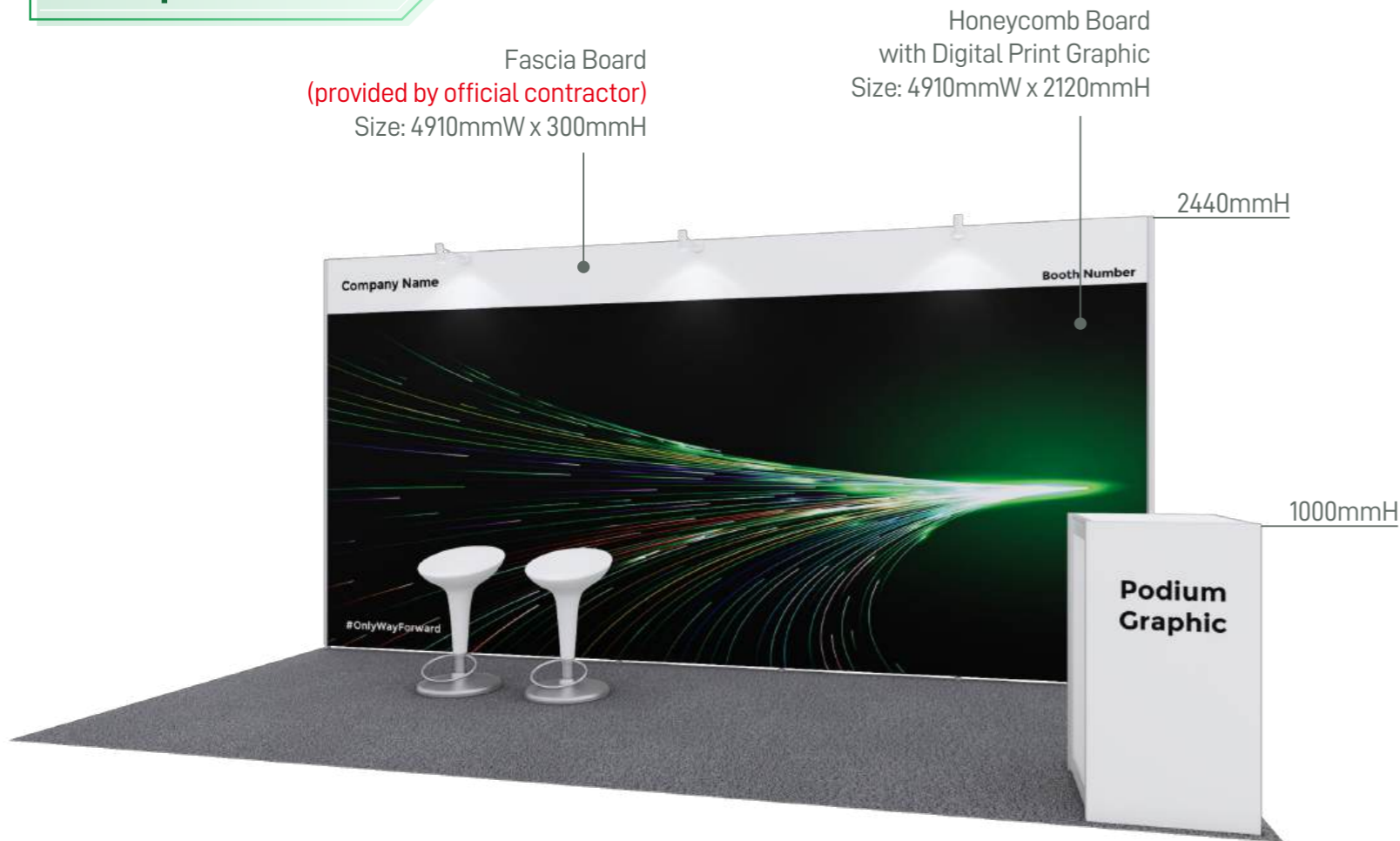

## Layout plan

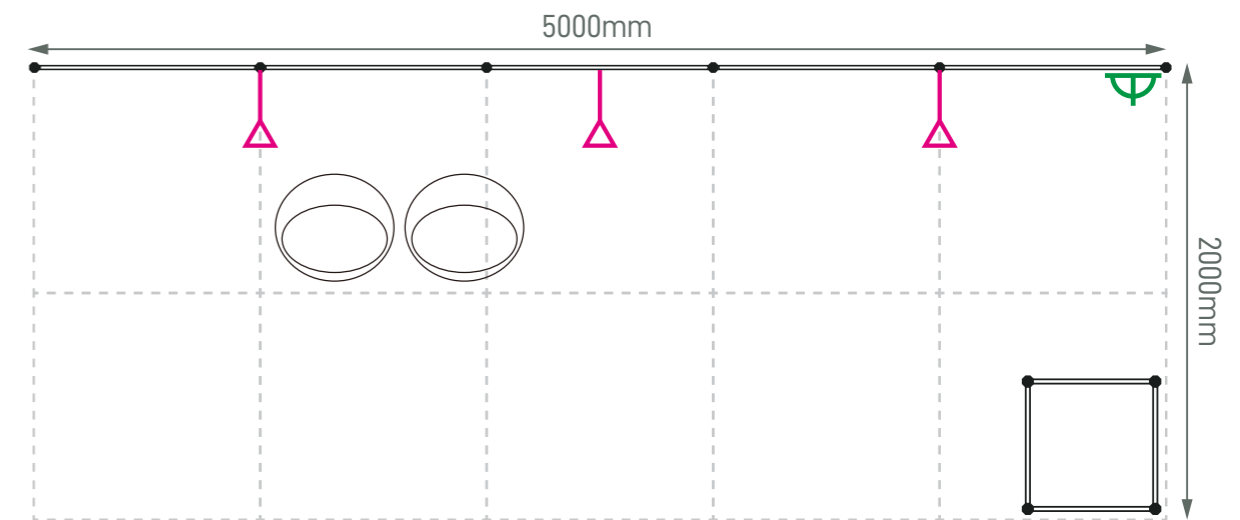

## Graphic Submission

Display Area / Graphic Size:  
4910mmW x 2120mmH

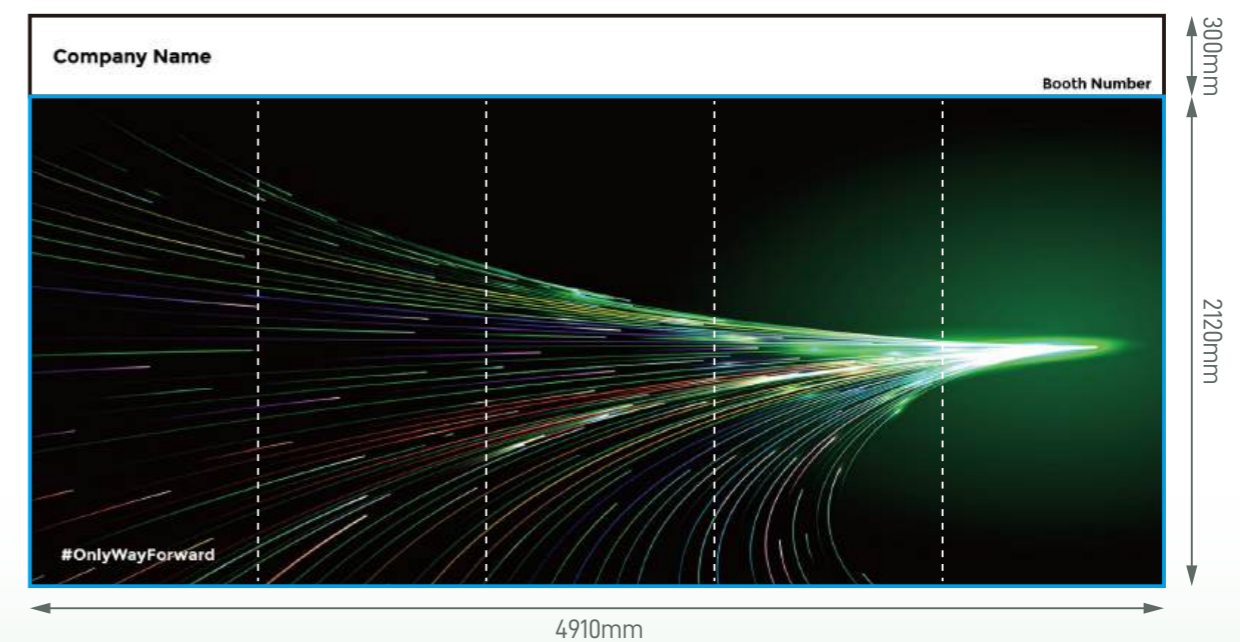

### Legend

Legend	Qty
LED Longarm Spotlight	3
500W Square Pin Socket	1
Podium (0.5mW x 0.5mD x 1mH)	1
White Bar Stool	2

Revised Date: 27 May 2026 (V05)

# Standard Booth (E2L) - 5m x 2m

Size: 5000mmL x 2000mmD x 2440mmH

( Left opened )



10-11 SEPTEMBER 2026 | HONG KONG  
ASIA'S HUB FOR CLIMATE ACTION & SUSTAINABLE BUSINESS SOLUTIONS

## Perspective View

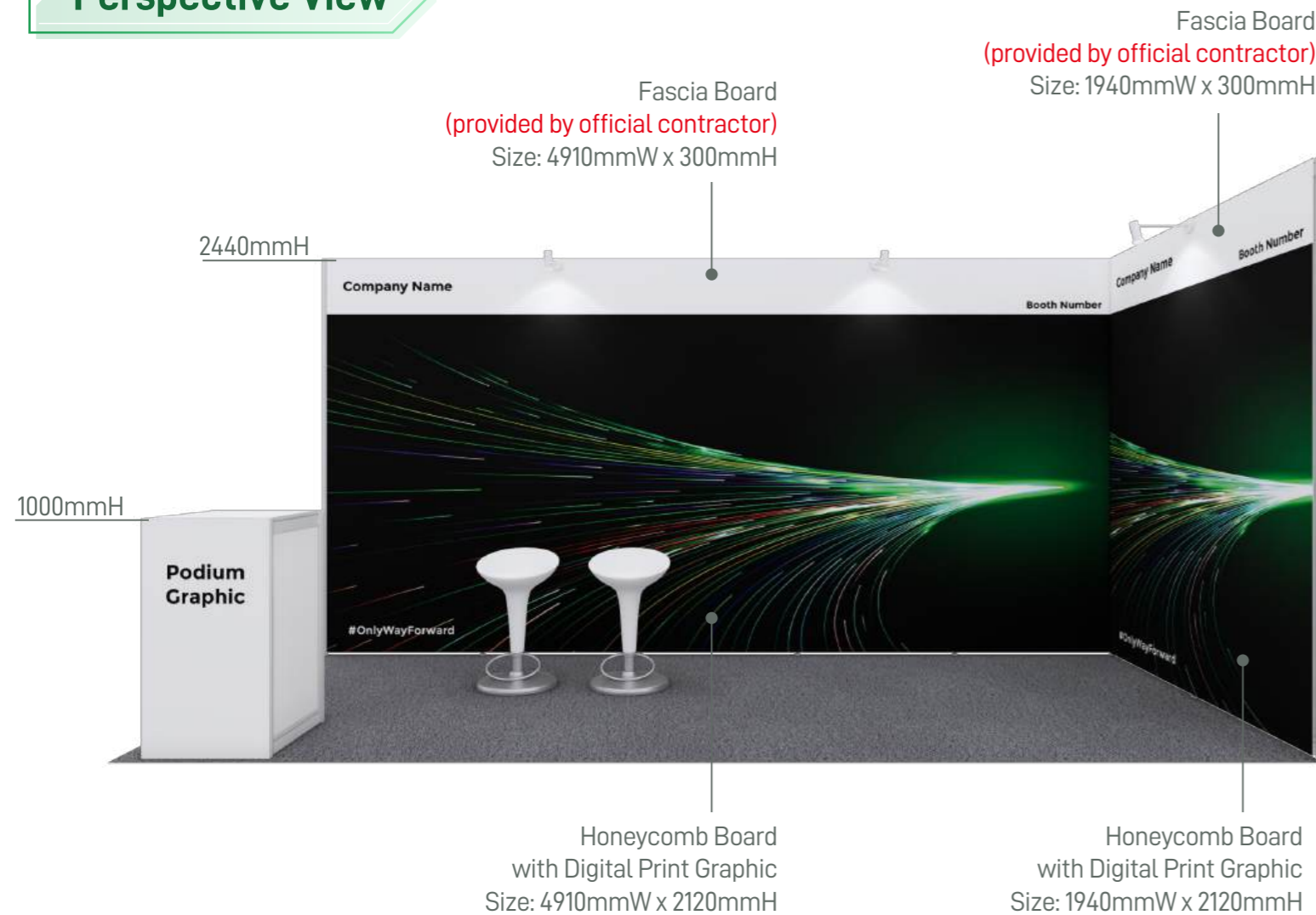

## Layout plan

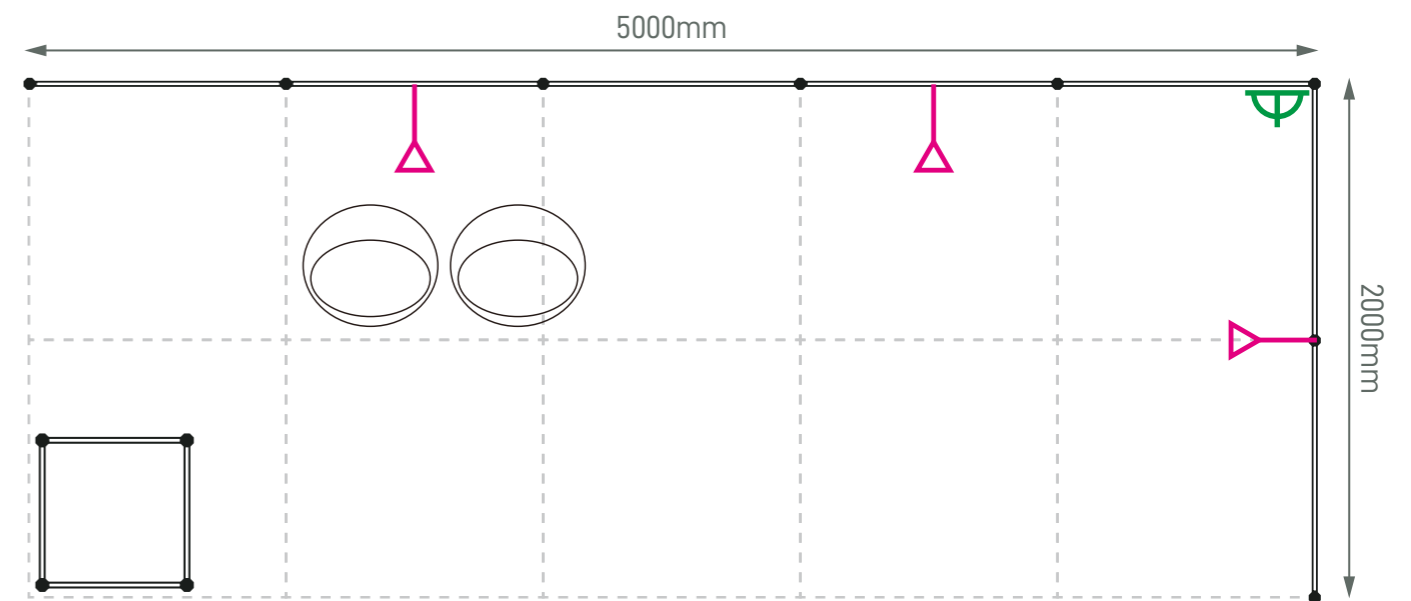

## Graphic Submission

Display Area / Graphic Size:  
4910mmW x 2120mmH

Display Area / Graphic Size:  
1940mmW x 2120mmH

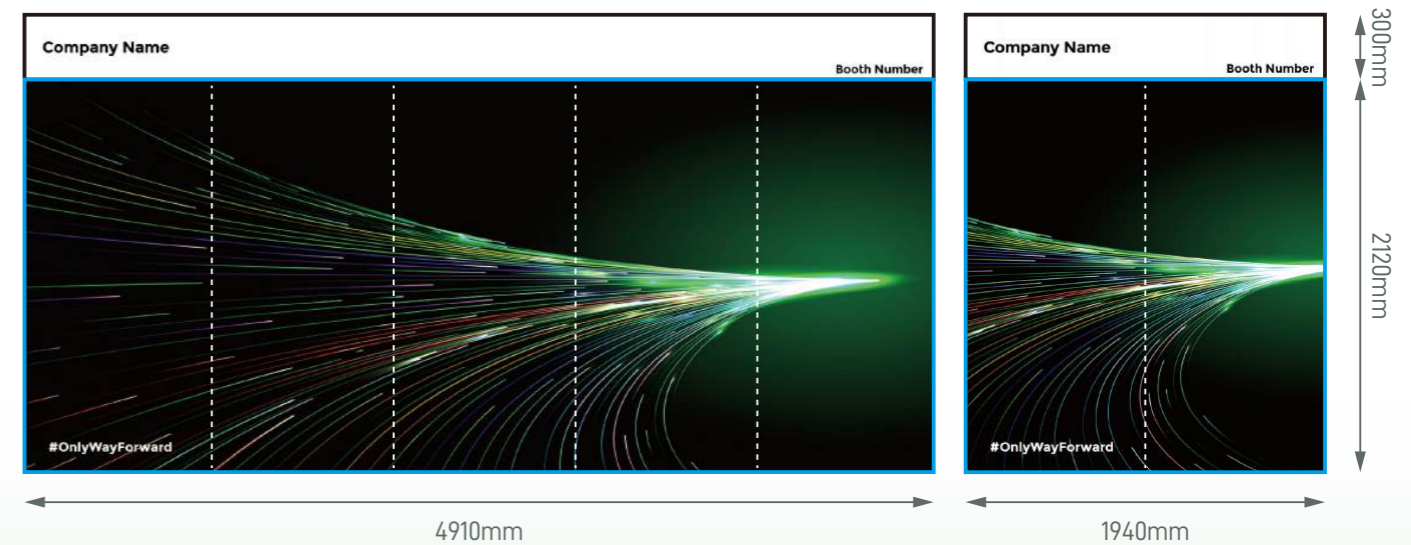

### Legend

	Qty
	3
	1
	1
	2

Revised Date: 27 May 2026 (V05)

# Standard Booth (E2R) - 5m x 2m

Size: 5000mmL x 2000mmD x 2440mmH

( Right opened )



10-11 SEPTEMBER 2026 | HONG KONG  
ASIA'S HUB FOR CLIMATE ACTION & SUSTAINABLE BUSINESS SOLUTIONS

## Perspective View

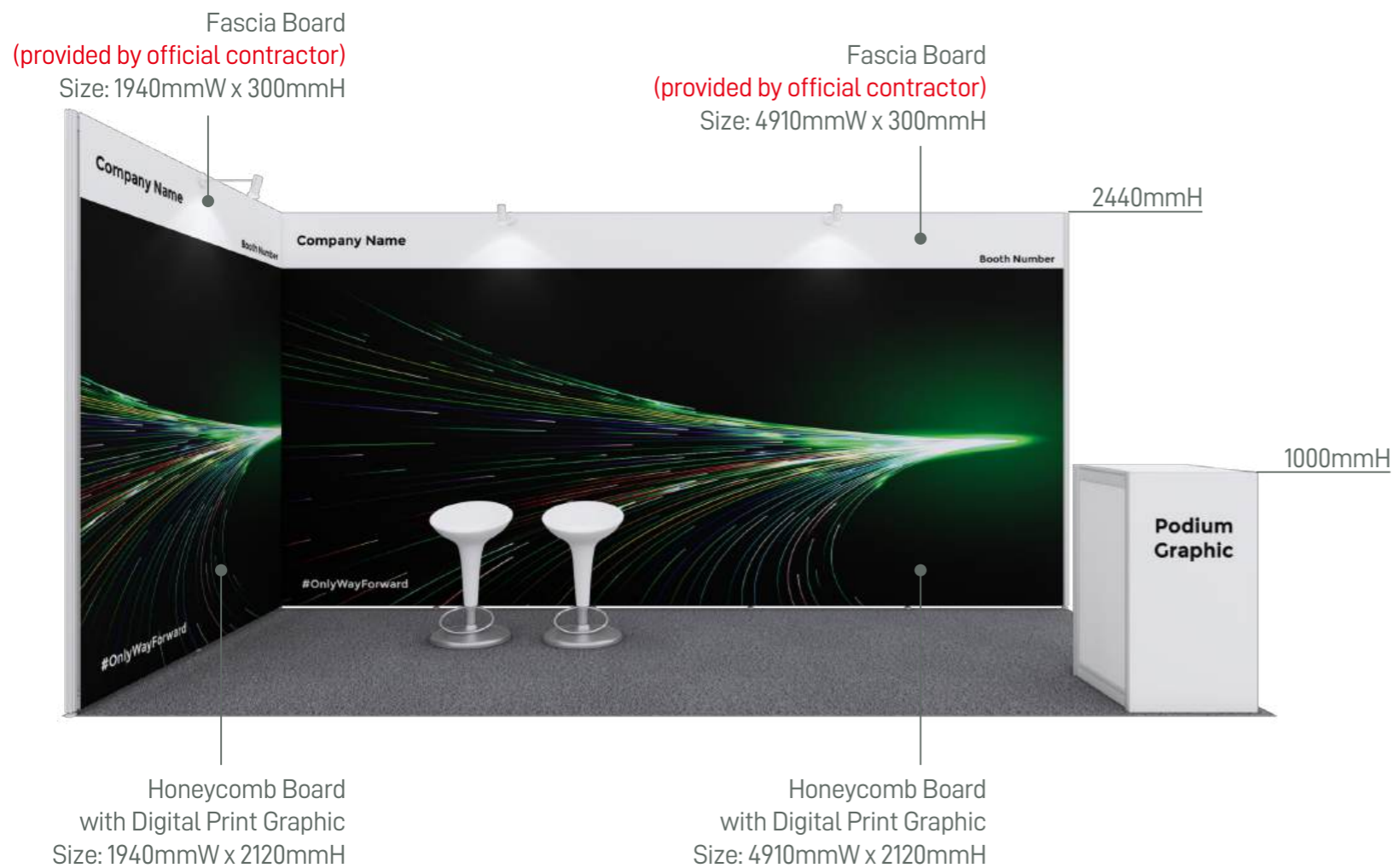

## Layout plan

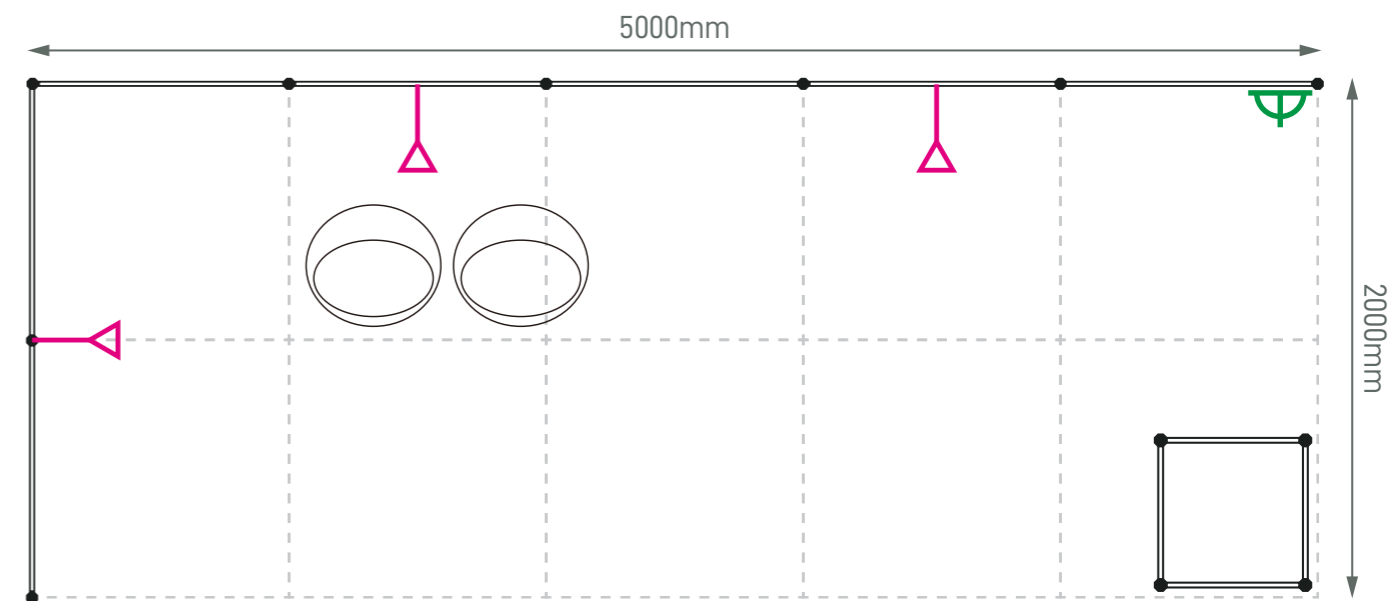

## Graphic Submission

Display Area / Graphic Size:  
4910mmW x 2120mmH

Display Area / Graphic Size:  
1940mmW x 2120mmH

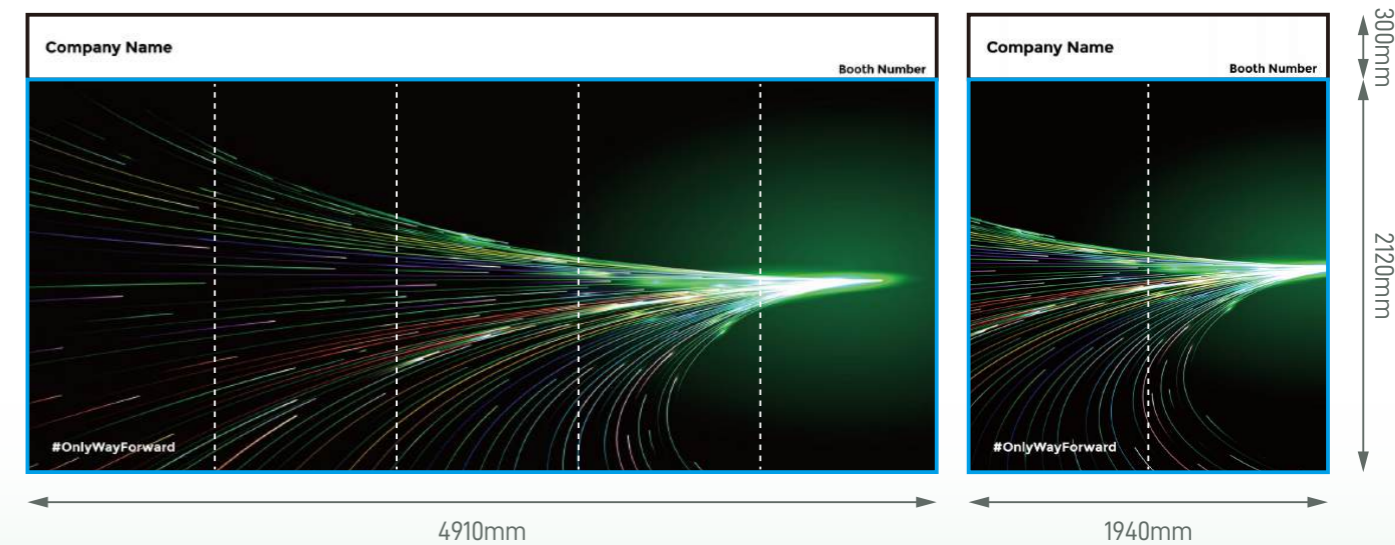

### Legend

	Qty
	3
	1
	1
	2

Revised Date: 27 May 2026 (V05)

# Standard Booth (F1) - 4m x 3m

Size: 4000mmL x 3000mmD x 2440mmH



10-11 SEPTEMBER 2026 | HONG KONG  
ASIA'S HUB FOR CLIMATE ACTION & SUSTAINABLE BUSINESS SOLUTIONS

## Perspective View

Fascia Board  
(provided by official contractor)  
Size: 3920mmW x 300mmH

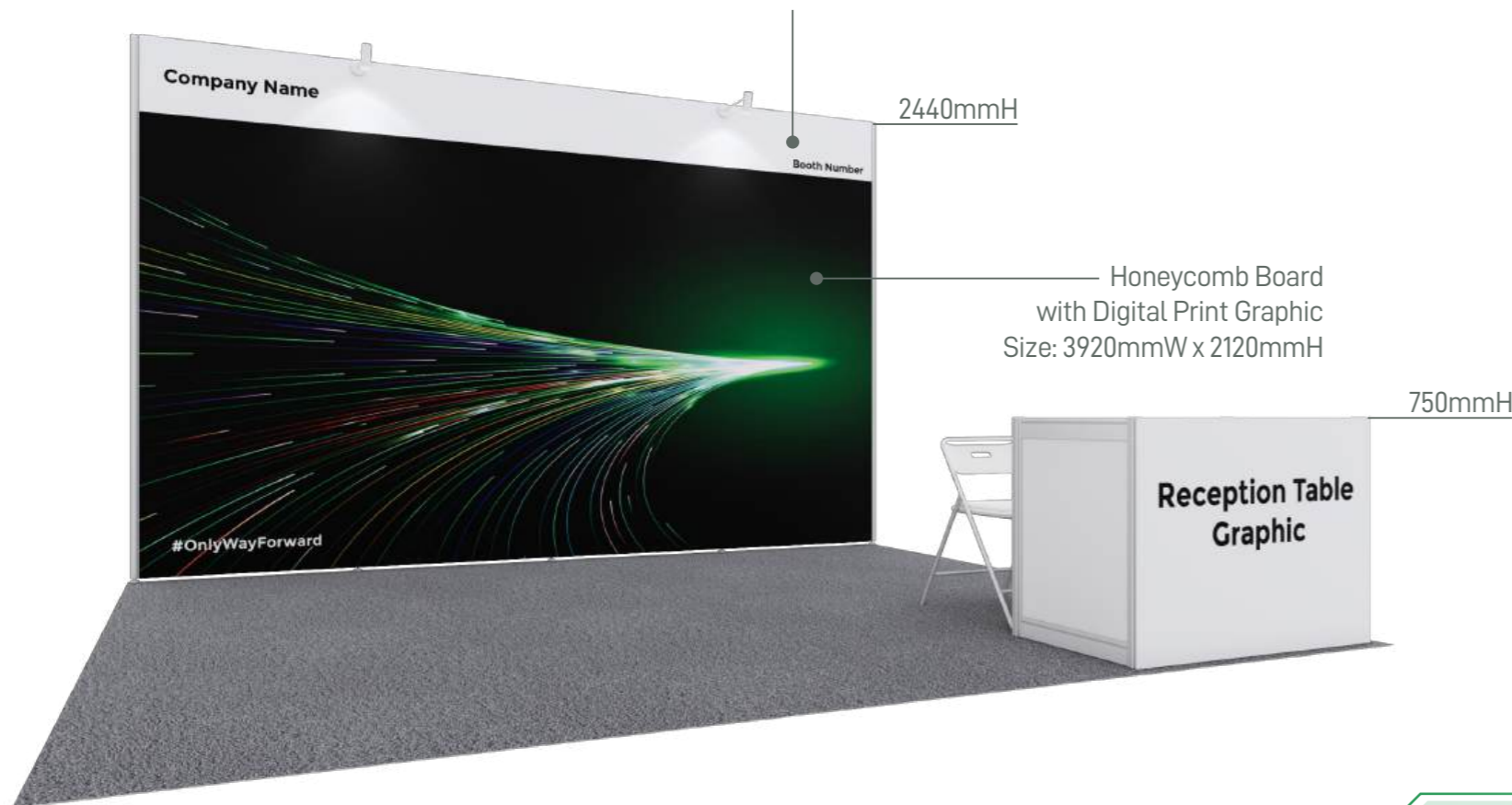

## Layout plan

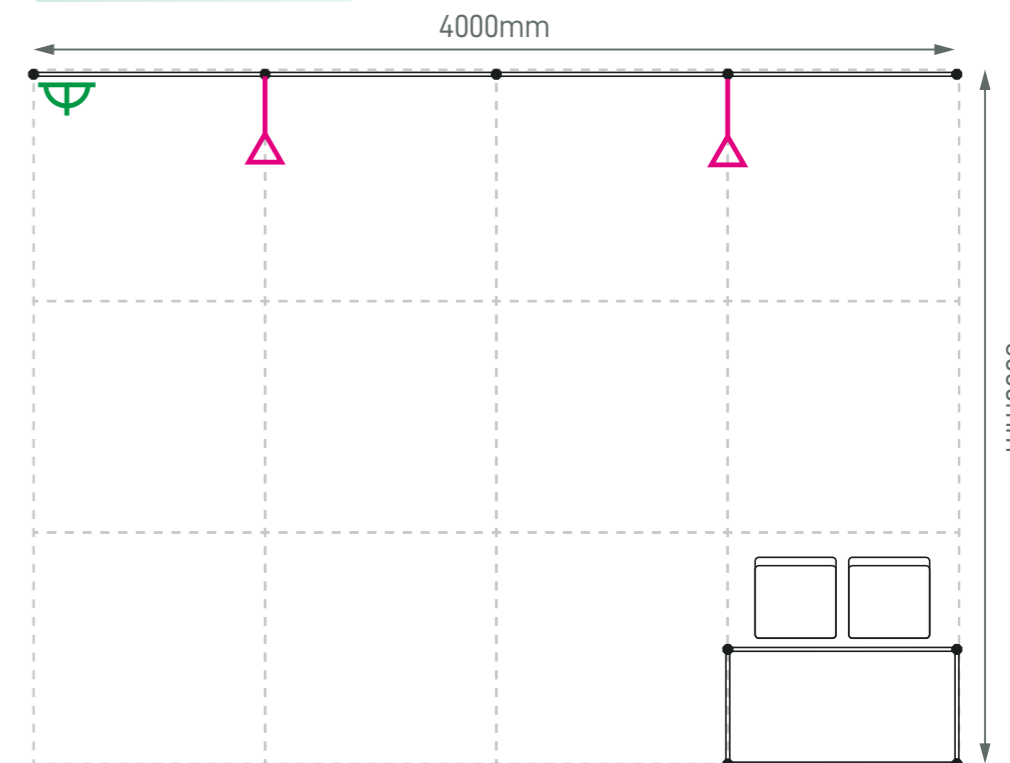

## Graphic Submission

Display Area / Graphic Size:  
3920mmW x 2120mmH

Legend	Qty
LED Longarm Spotlight	2
500W Square Pin Socket	1
Reception Desk (1mW x 0.5mD x 0.75mH)	1
Folding Chair	2

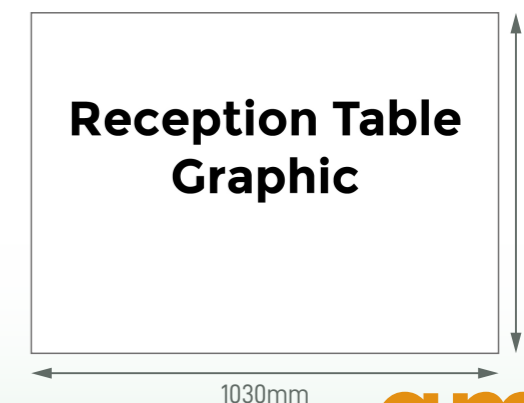
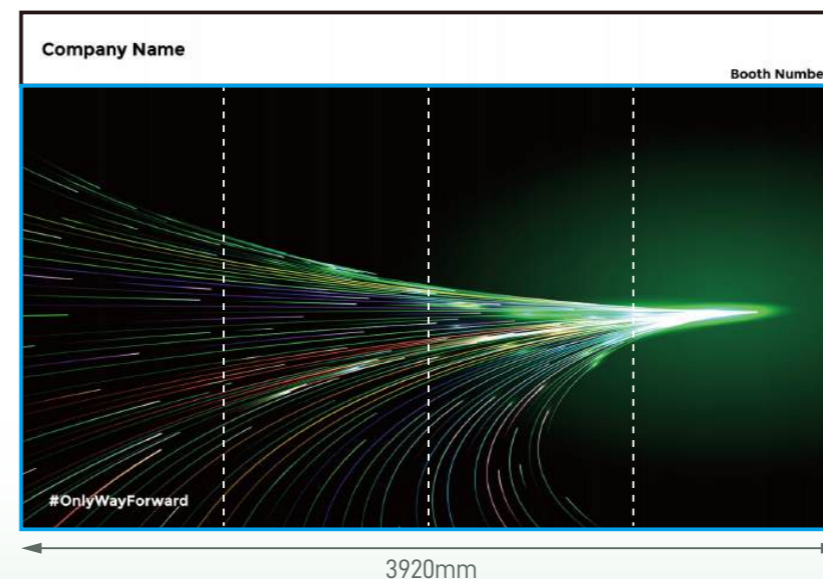

Revised Date: 27 May 2026 (V05)

# Standard Booth (F2) - 6m x 2m

Size: 6000mmL x 2000mmD x 2440mmH



10-11 SEPTEMBER 2026 | HONG KONG  
ASIA'S HUB FOR CLIMATE ACTION & SUSTAINABLE BUSINESS SOLUTIONS

## Perspective View

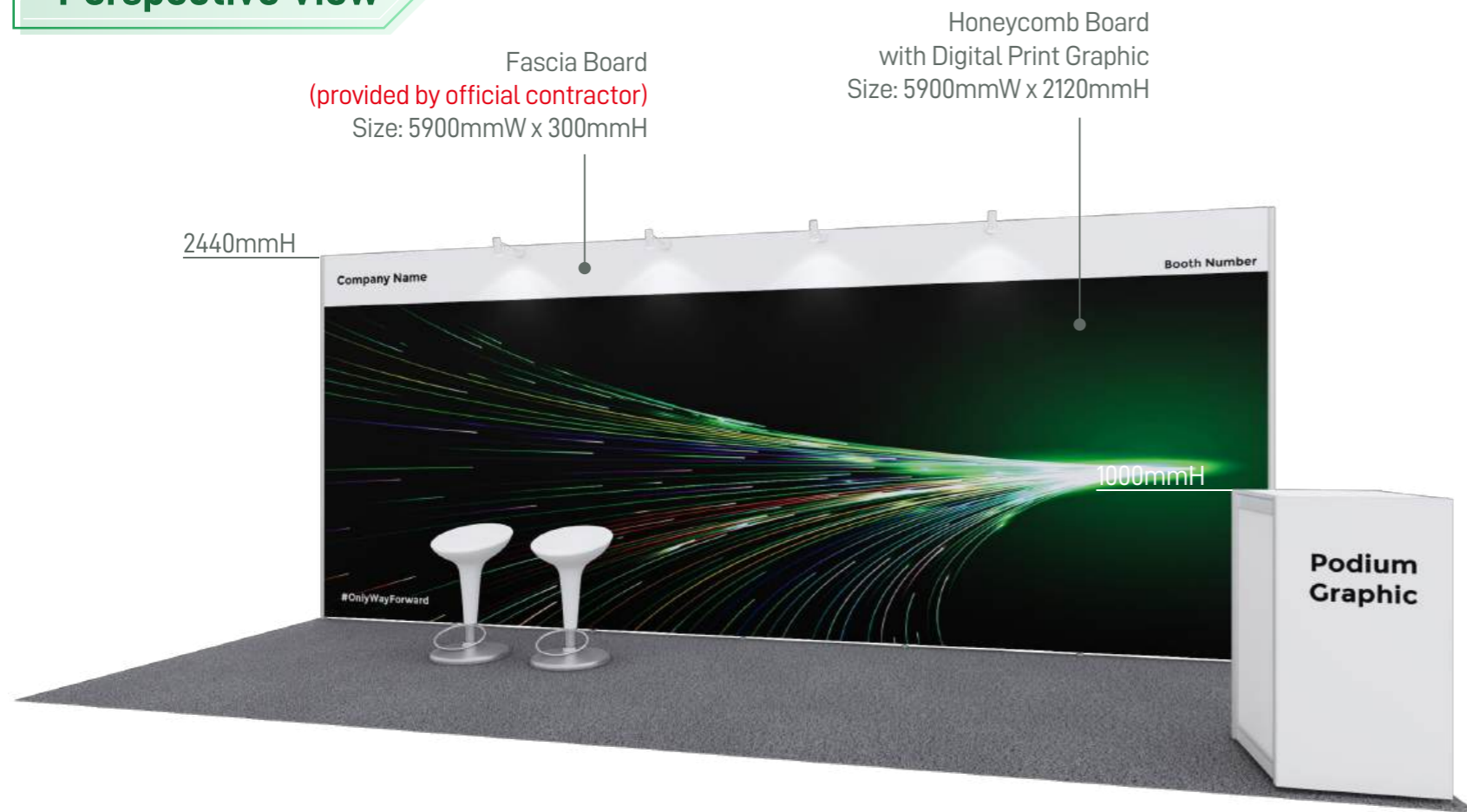

## Layout plan

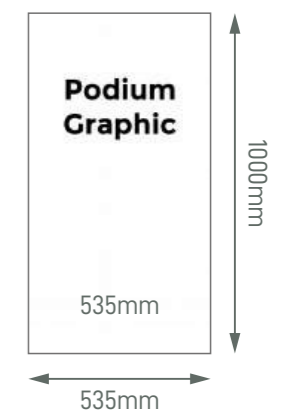
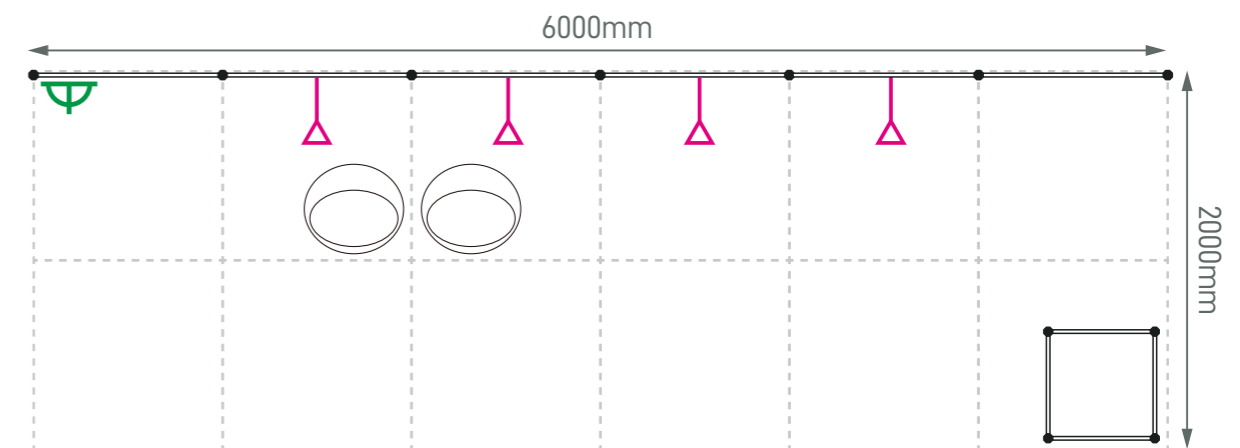

## Graphic Submission

Display Area / Graphic Size:  
5900mmW x 2120mmH

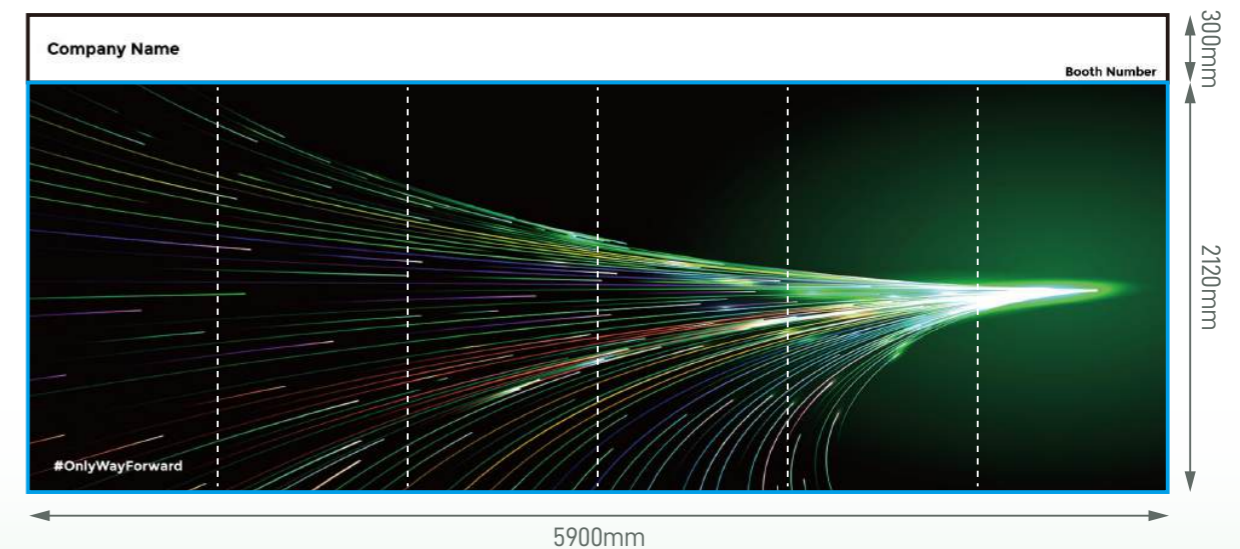

### Legend Qty

	LED Longarm Spotlight	4
	500W Square Pin Socket	1
	Podium (0.5mW x 0.5mD x 1mH)	1
	White Bar Stool	2

Revised Date: 27 May 2026 (V05)

The drawing is the property of AMC (Exhibits) Ltd and we reserve the copyright to all our designs which cannot be reproduced (whether part / whole or modified) without first obtaining our written consent. Contravention will be prosecuted. The drawing is subjected to modification of its design & measurement from time to time to suit construction purpose.

**amc**  
AMC (Exhibits) Ltd  
建同展覽有限公司



# Standard Booth (F3R) - 4m x 3m

Size: 4000mmL x 3000mmD x 2440mmH

( Right opened )



10-11 SEPTEMBER 2026 | HONG KONG  
ASIA'S HUB FOR CLIMATE ACTION & SUSTAINABLE BUSINESS SOLUTIONS

## Perspective View

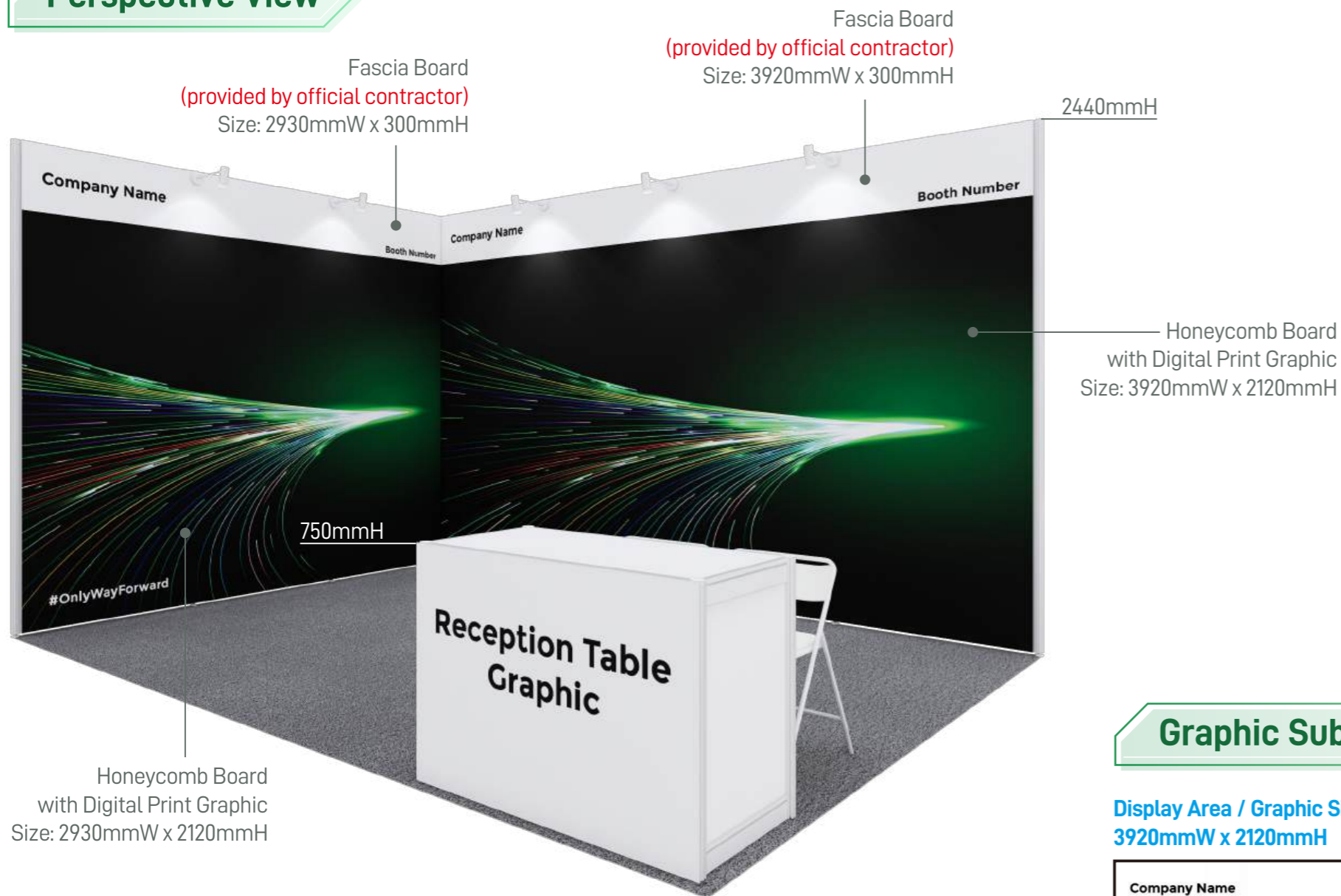

## Layout plan

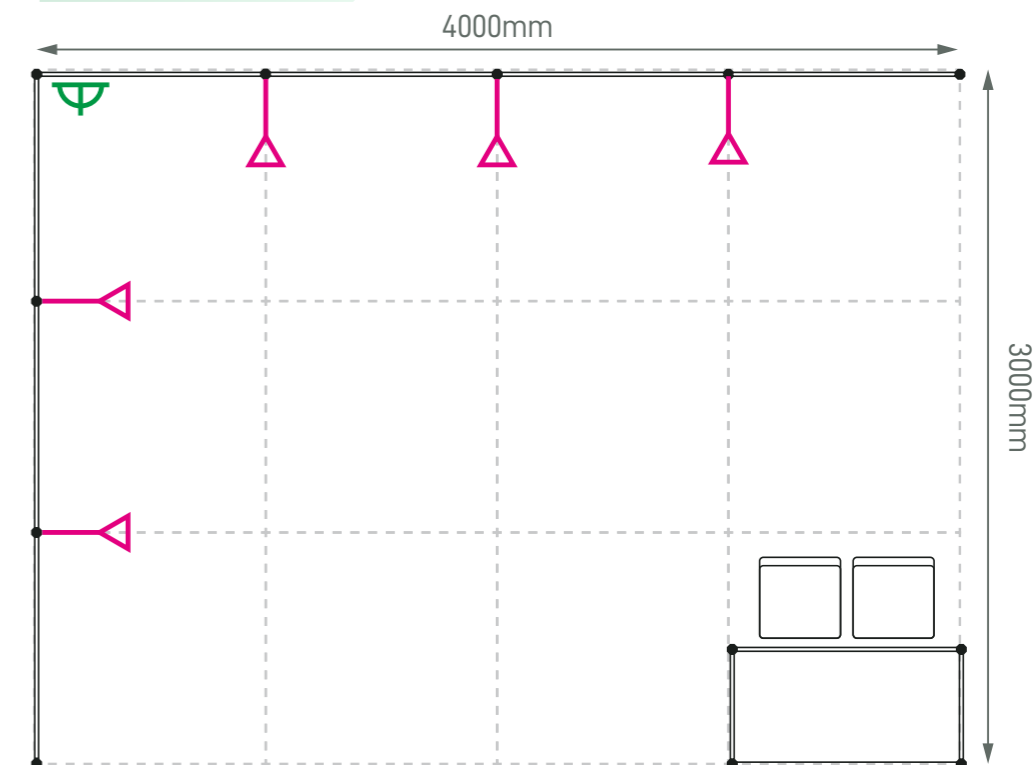

## Graphic Submission

Display Area / Graphic Size:  
3920mmW x 2120mmH

Display Area / Graphic Size:  
2930mmW x 2120mmH

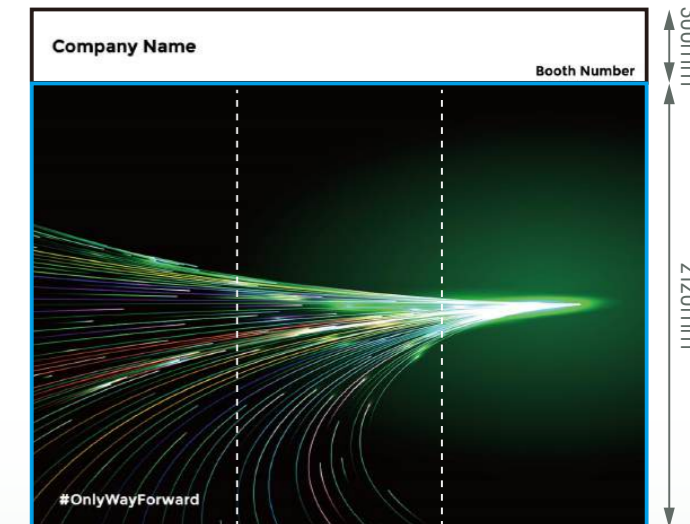
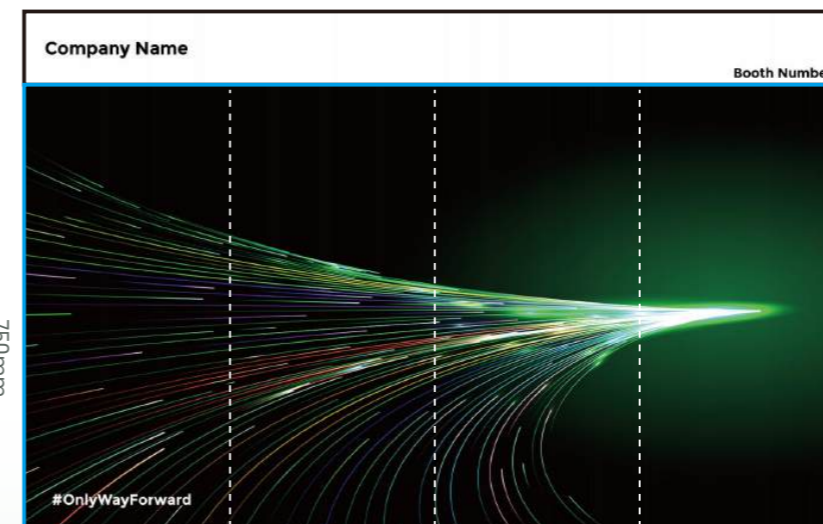

### Legend

	Qty
	LED Longarm Spotlight 5
	500W Square Pin Socket 1
	Reception Desk (1mW x 0.5mD x 0.75mH) 1
	Folding Chair 2

Revised Date: 27 May 2026 (V05)

**amc**  
AMC (Exhibits) Ltd  
建同展覽有限公司

# Standard Booth (G1) - 5m x 3m

Size: 5000mmL x 3000mmD x 2440mmH



10-11 SEPTEMBER 2026 | HONG KONG  
ASIA'S HUB FOR CLIMATE ACTION & SUSTAINABLE BUSINESS SOLUTIONS

## Perspective View

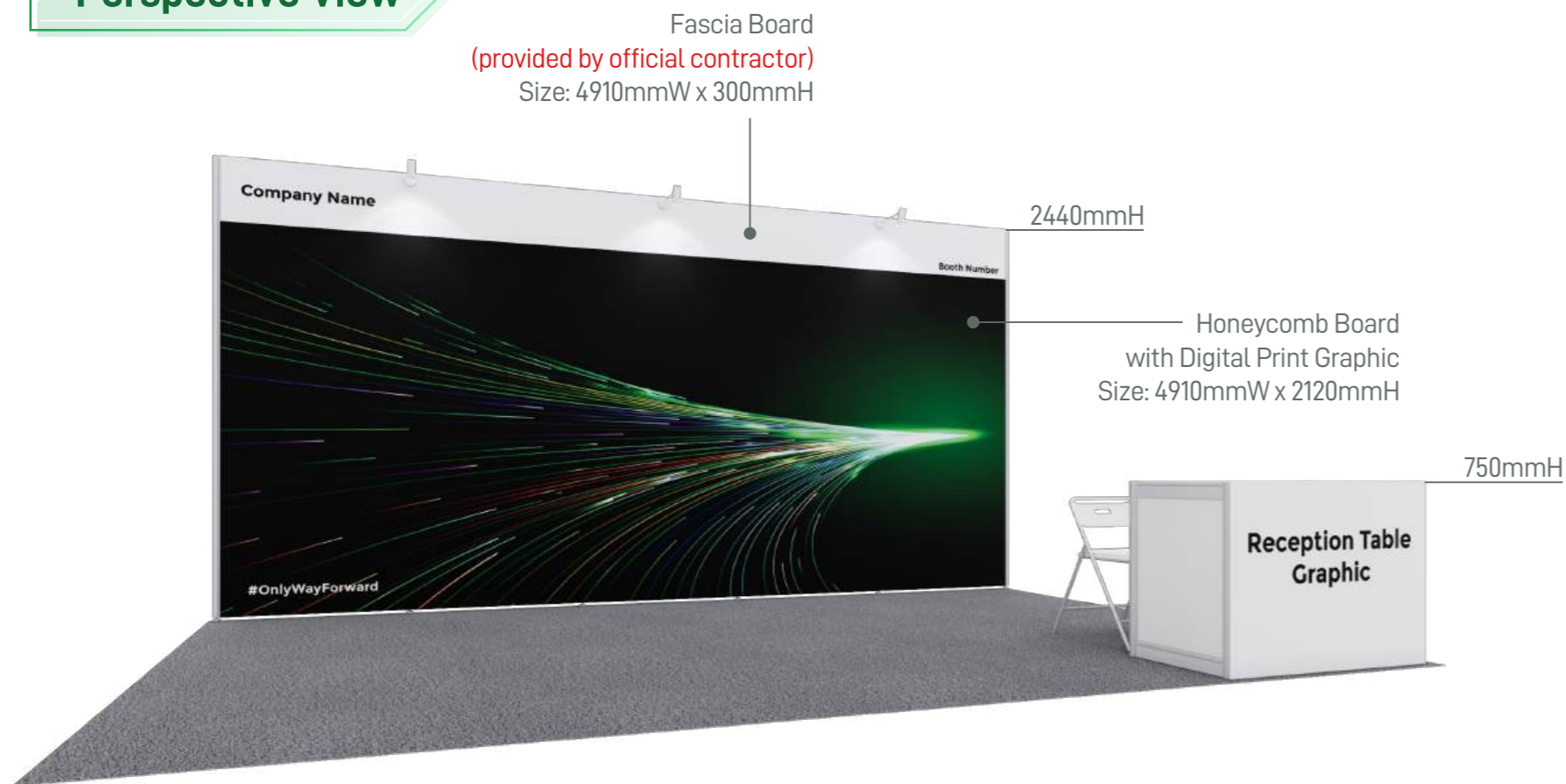

## Layout plan

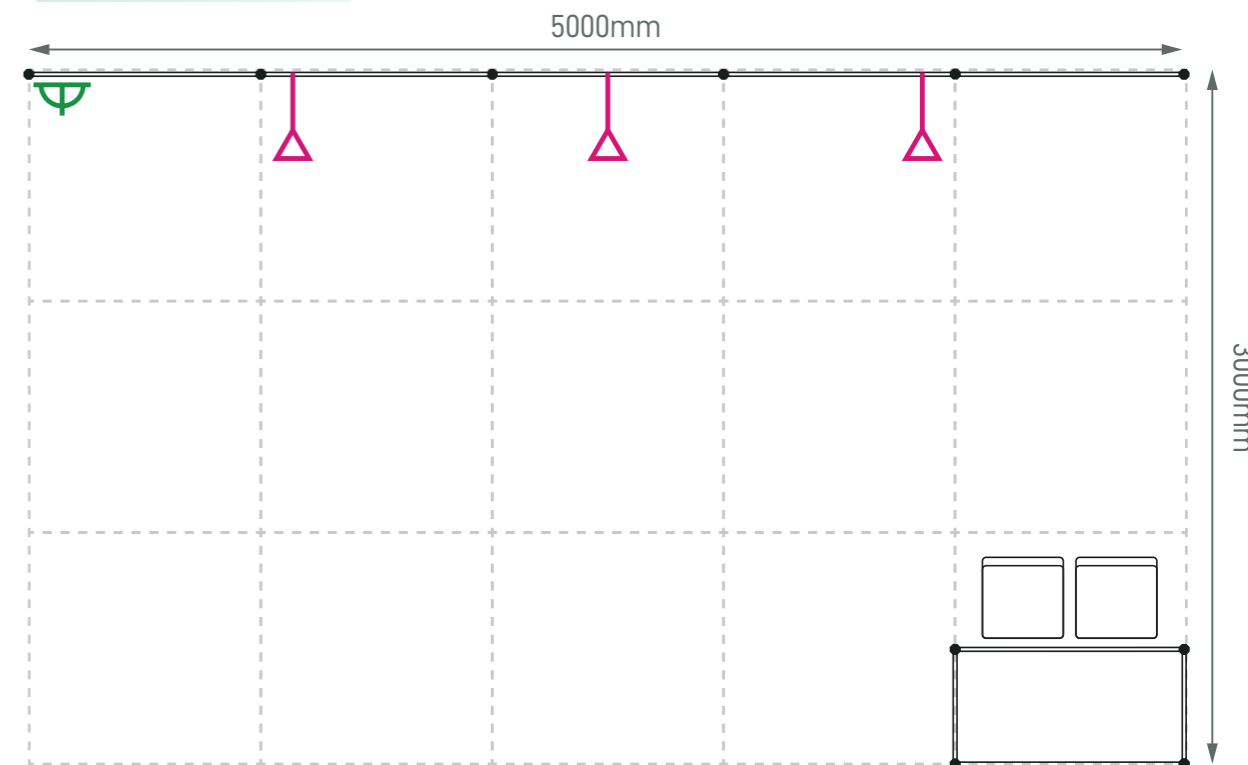

## Graphic Submission

Display Area / Graphic Size:  
4910mmW x 2120mmH

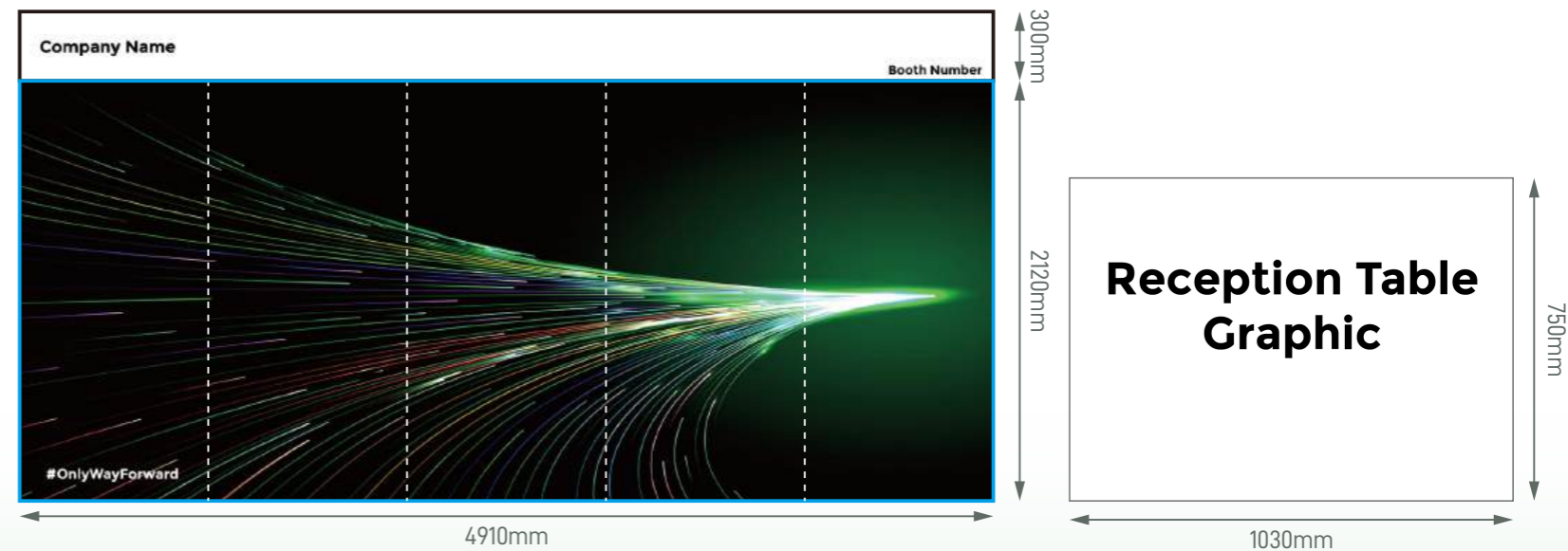

### Legend

Qty

	LED Longarm Spotlight	3
	500W Square Pin Socket	1
	Reception Desk (1mW x 0.5mD x 0.75mH)	1
	Folding Chair	2

Revised Date: 27 May 2026 (V05)

# Standard Booth (G2L) - 5m x 3m

Size: 5000mmL x 3000mmD x 2440mmH

( Left opened )



10-11 SEPTEMBER 2026 | HONG KONG  
ASIA'S HUB FOR CLIMATE ACTION & SUSTAINABLE BUSINESS SOLUTIONS

## Perspective View

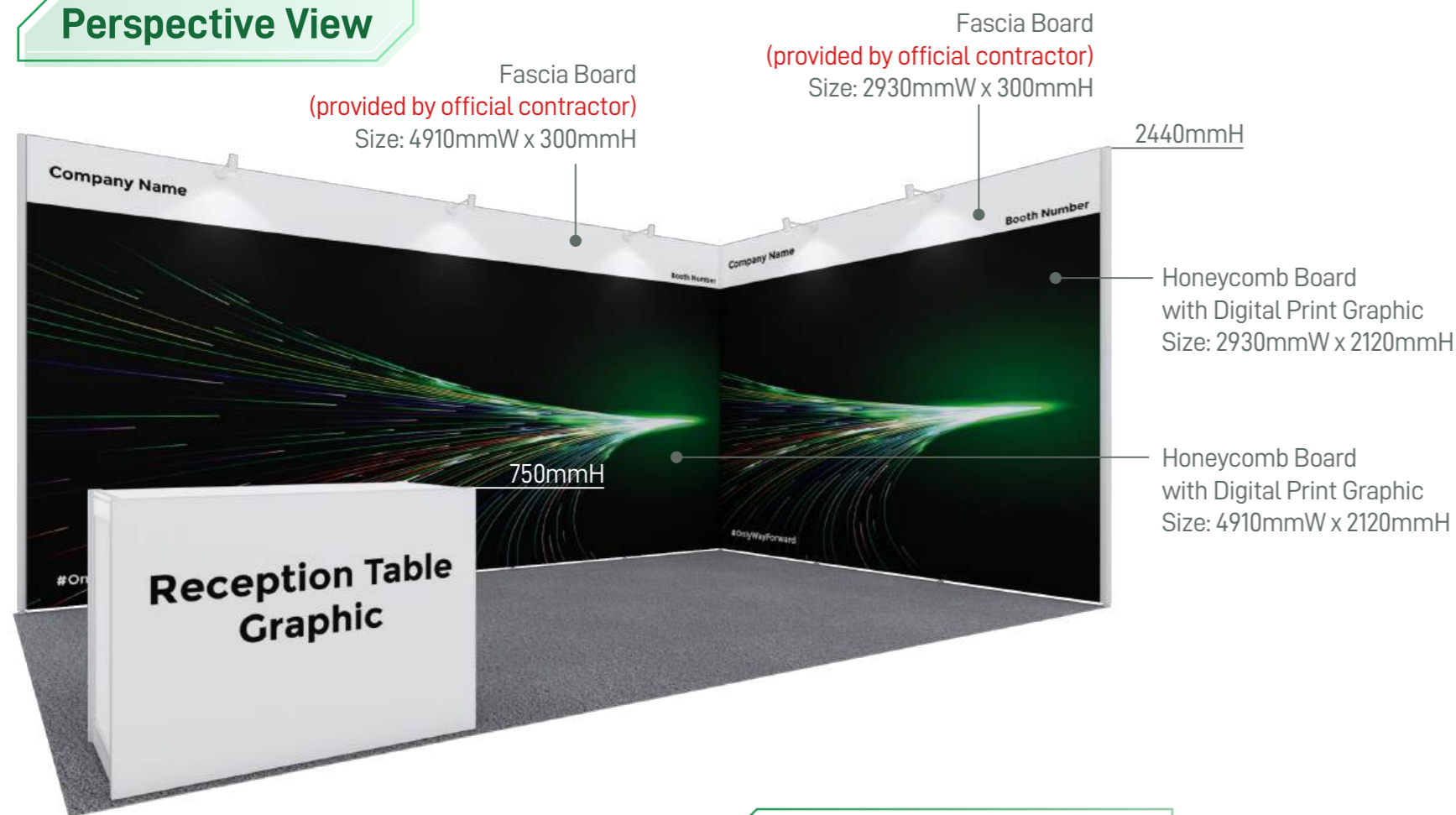

## Layout plan

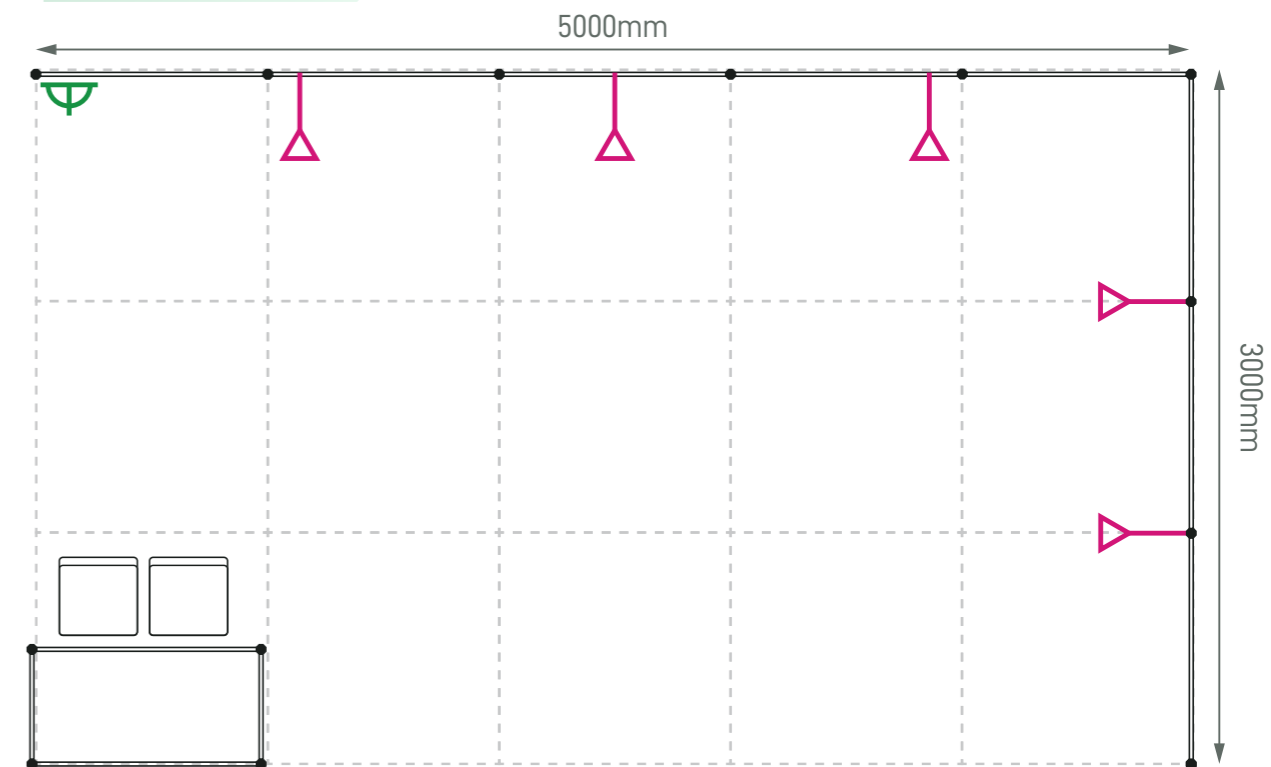

## Graphic Submission

Display Area / Graphic Size:  
4910mmW x 2120mmH

Display Area / Graphic Size:  
2930mmW x 2120mmH

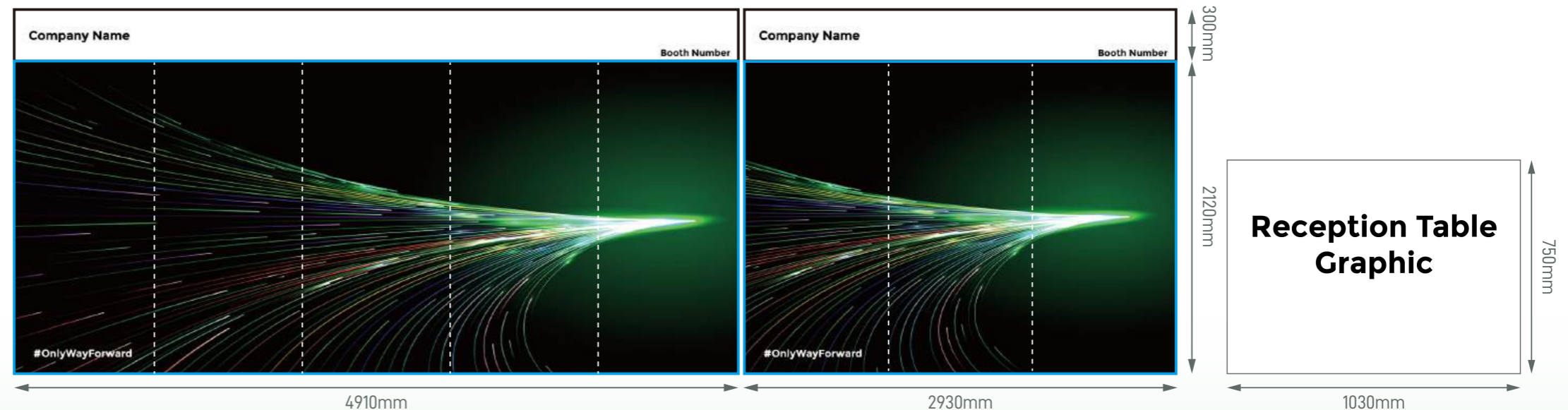

### Legend Qty

- |  |                                       |   |
|--|---------------------------------------|---|
|  | LED Longarm Spotlight                 | 5 |
|  | 500W Square Pin Socket                | 1 |
|  | Reception Desk (1mW x 0.5mD x 0.75mH) | 1 |
|  | Folding Chair                         | 2 |

Revised Date: 27 May 2026 (V05)

# Standard Booth (G2R) - 5m x 3m

Size: 5000mmL x 3000mmD x 2440mmH

( Right opened )



10-11 SEPTEMBER 2026 | HONG KONG  
ASIA'S HUB FOR CLIMATE ACTION & SUSTAINABLE BUSINESS SOLUTIONS

## Perspective View

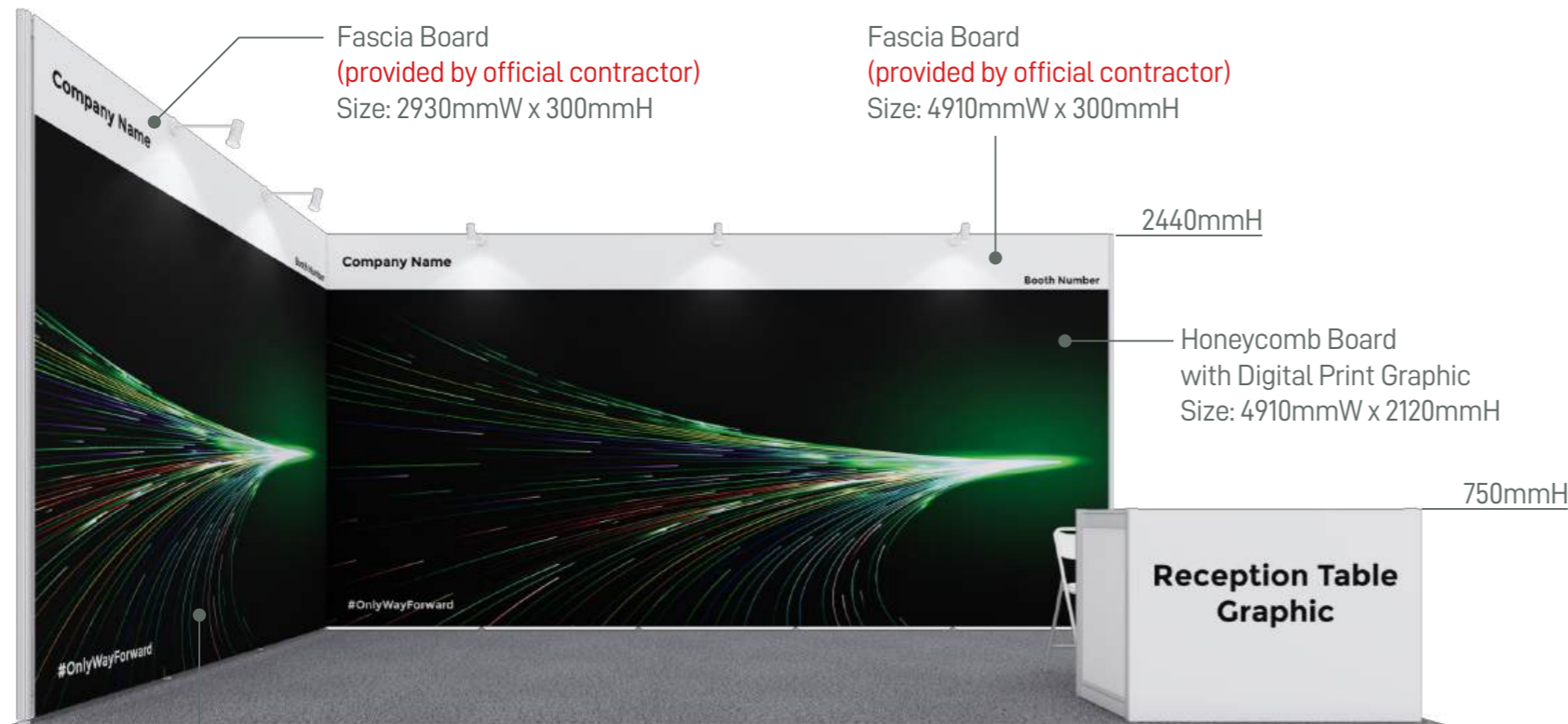

Honeycomb Board  
with Digital Print Graphic  
Size: 2930mmW x 2120mmH

## Layout plan

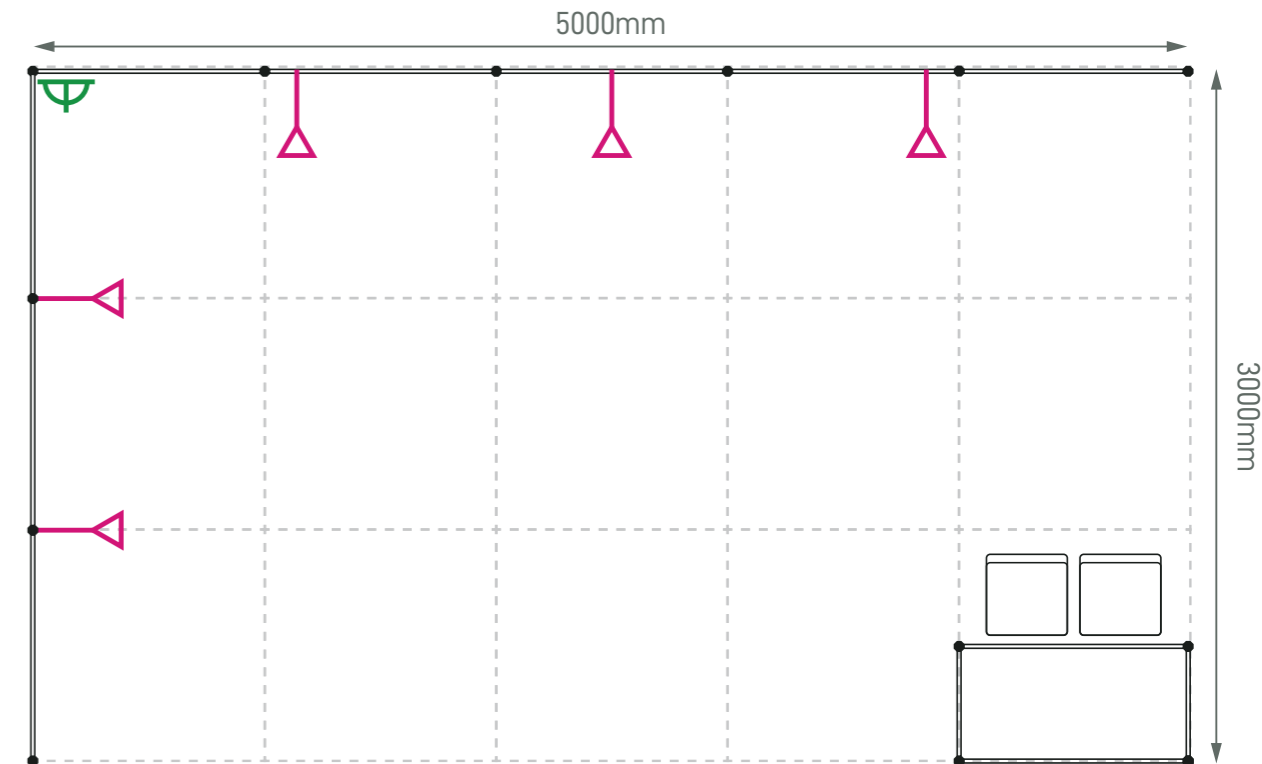

## Graphic Submission

Display Area / Graphic Size:  
4910mmW x 2120mmH

Display Area / Graphic Size:  
2930mmW x 2120mmH

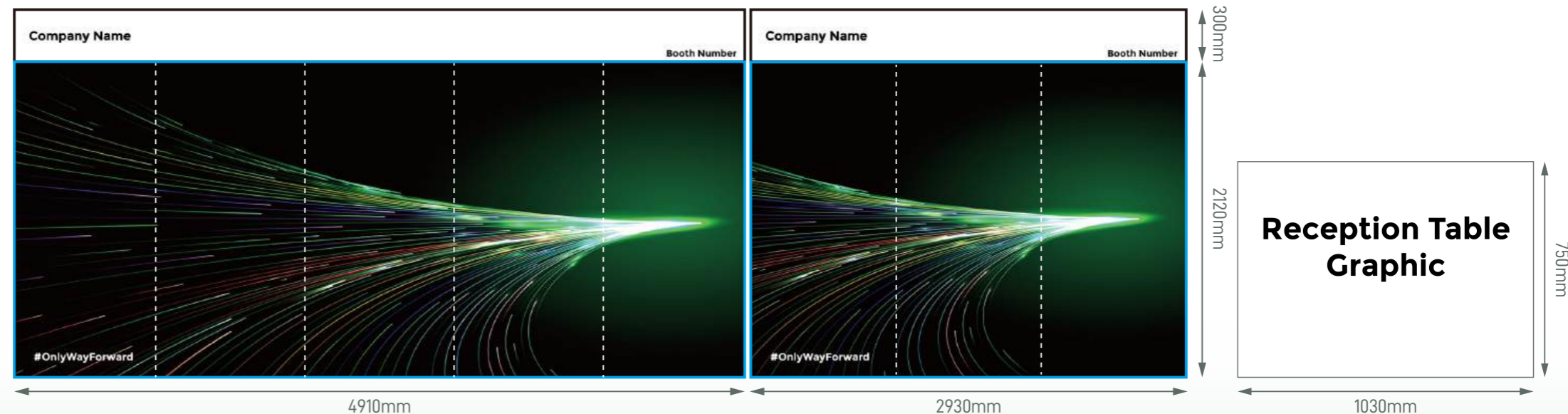

### Legend

	Qty
	5
	1
	1
	2

Revised Date: 27 May 2026 (V05)

**amc**  
AMC (Exhibits) Ltd  
建同展覽有限公司

# Standard Booth (H) - 4m x 4m

Size: 4000mmL x 4000mmD x 2440mmH



10-11 SEPTEMBER 2026 | HONG KONG  
ASIA'S HUB FOR CLIMATE ACTION & SUSTAINABLE BUSINESS SOLUTIONS

## Perspective View



## Layout plan

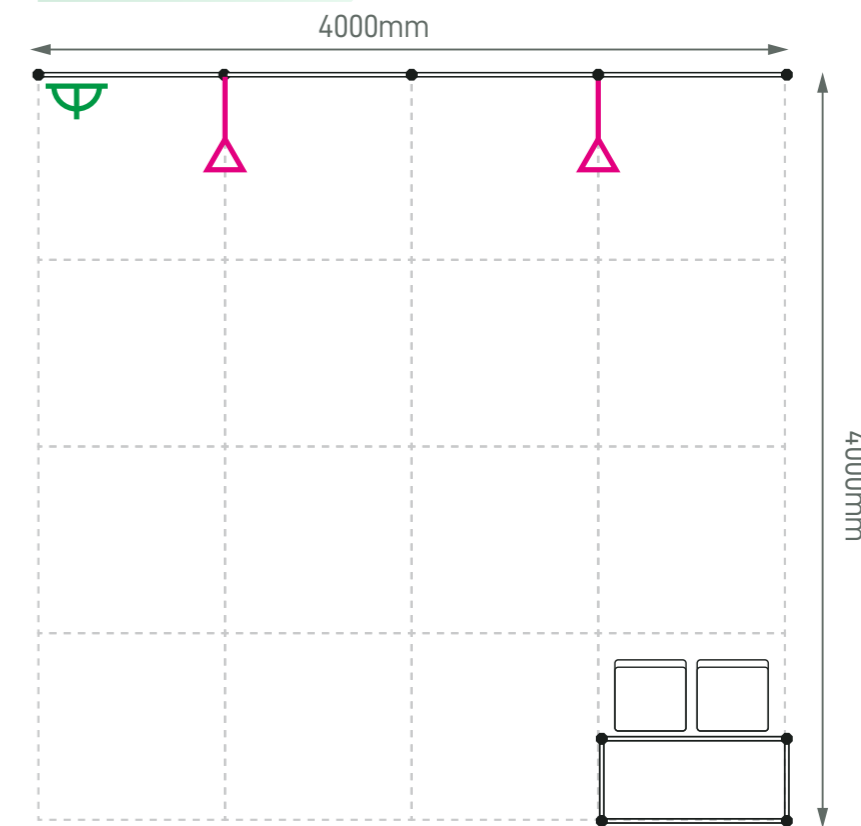

## Graphic Submission

Display Area / Graphic Size:  
3920mmW x 2120mmH

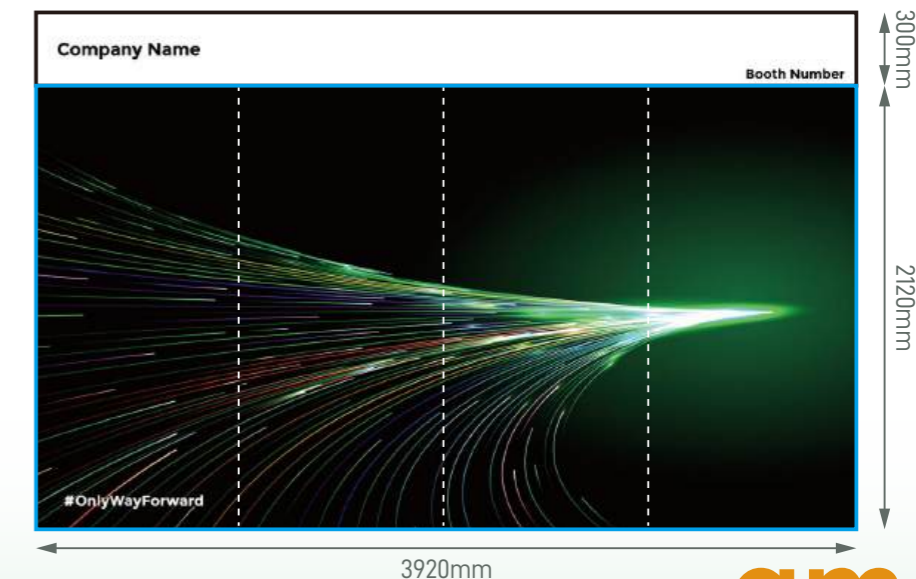

### Legend

Legend	Qty
	LED Longarm Spotlight 2
	500W Square Pin Socket 1
	Reception Desk (1mW x 0.5mD x 0.75mH) 1
	Folding Chair 2



Revised Date: 27 May 2026 (V05)

# Standard Booth (H1) - 8m x 2m

Size: 8000mmL x 2000mmD x 2440mmH



10-11 SEPTEMBER 2026 | HONG KONG  
ASIA'S HUB FOR CLIMATE ACTION & SUSTAINABLE BUSINESS SOLUTIONS

## Perspective View

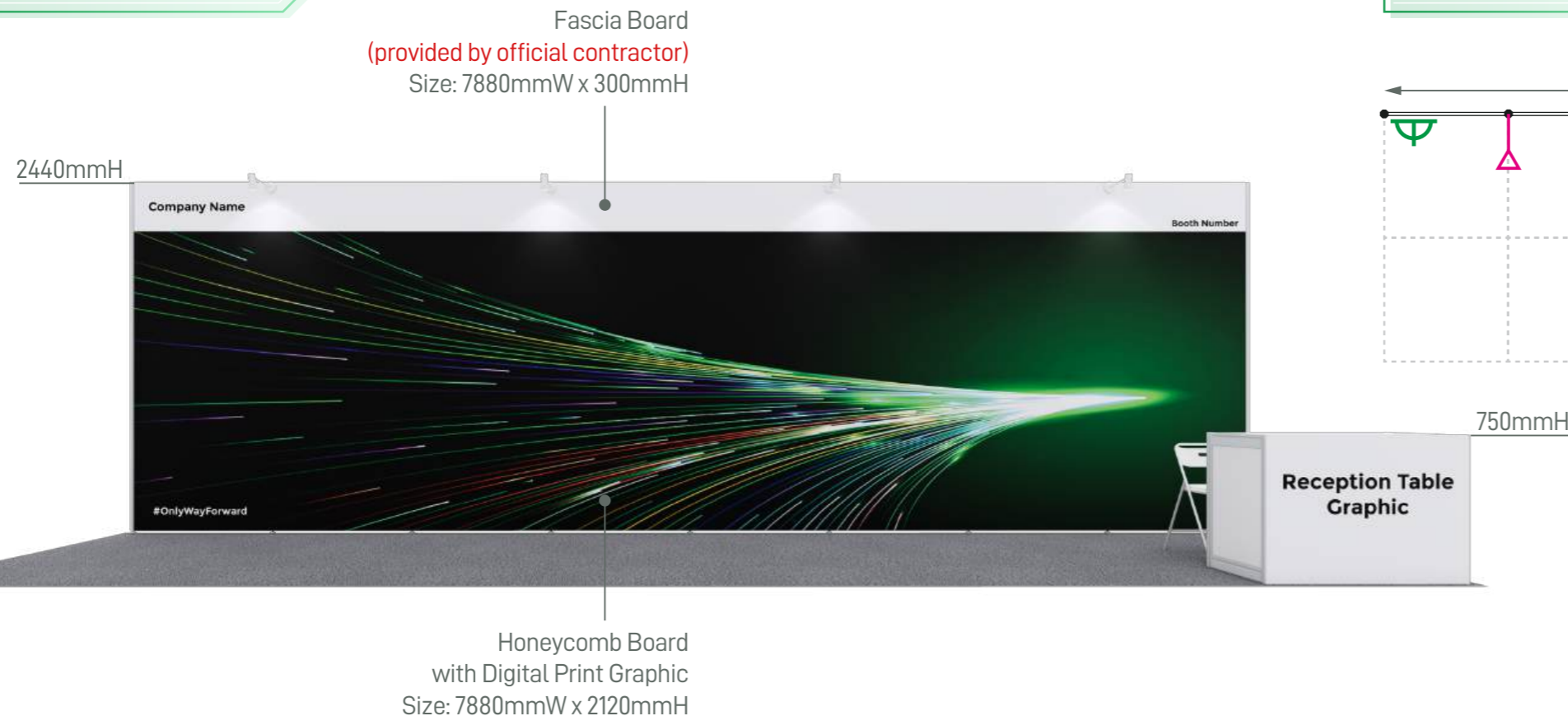

## Layout plan

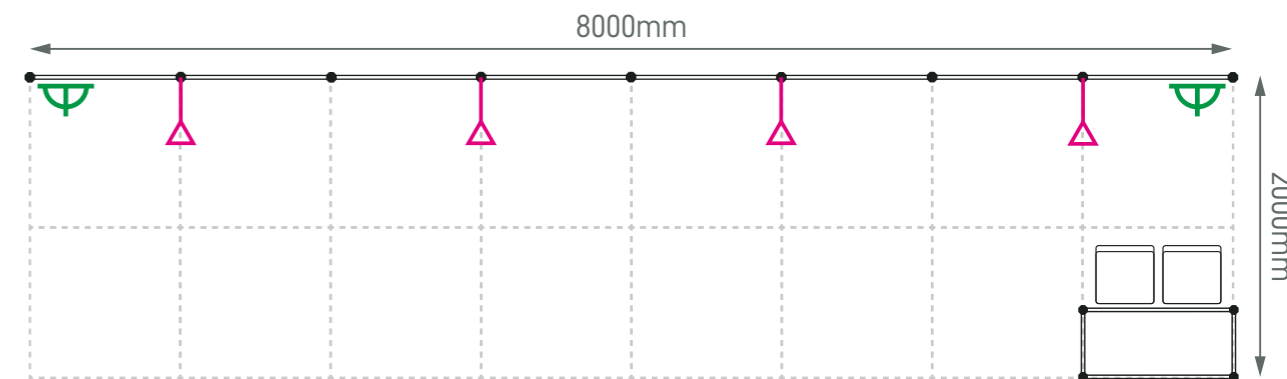

## Graphic Submission

Display Area / Graphic Size:  
7880mmW x 2120mmH

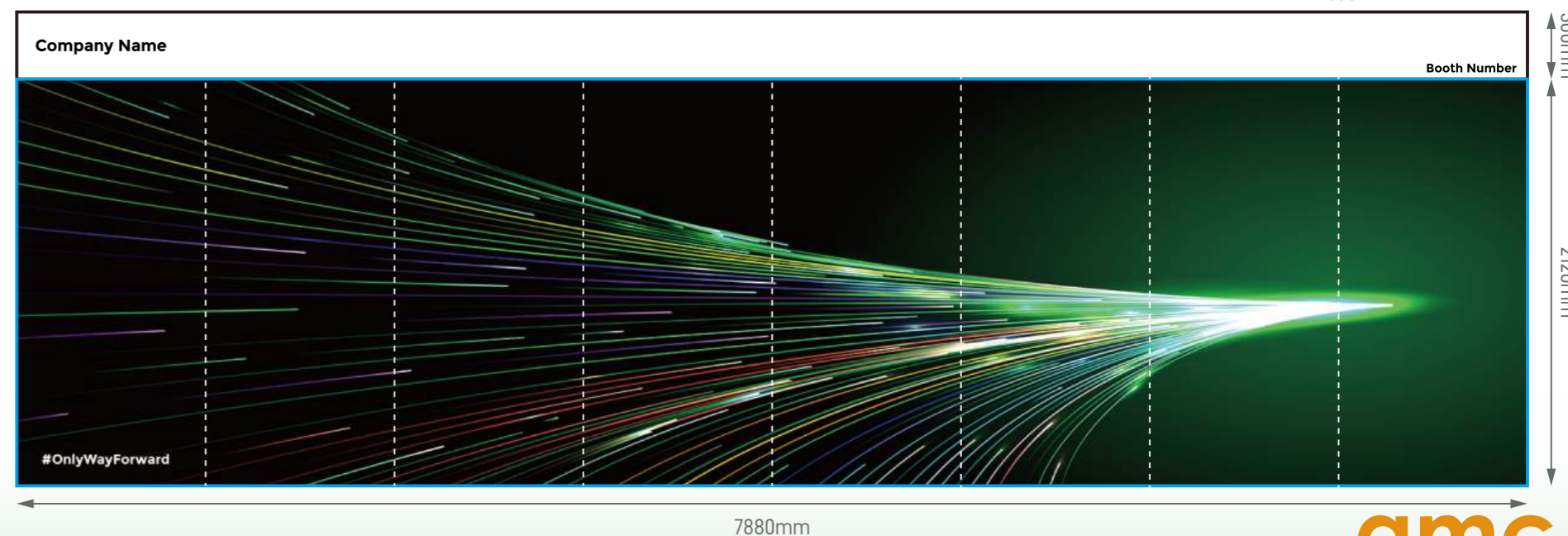

### Legend

### Qty

	LED Longarm Spotlight	4
	500W Square Pin Socket	2
	Reception Desk (1mW x 0.5mD x 0.75mH)	1
	Folding Chair	2

Revised Date: 27 May 2026 (V05)

# Standard Booth (J1) - 6m x 3m

Size: 6000mmL x 3000mmD x 2440mmH



10-11 SEPTEMBER 2026 | HONG KONG  
ASIA'S HUB FOR CLIMATE ACTION & SUSTAINABLE BUSINESS SOLUTIONS

## Perspective View

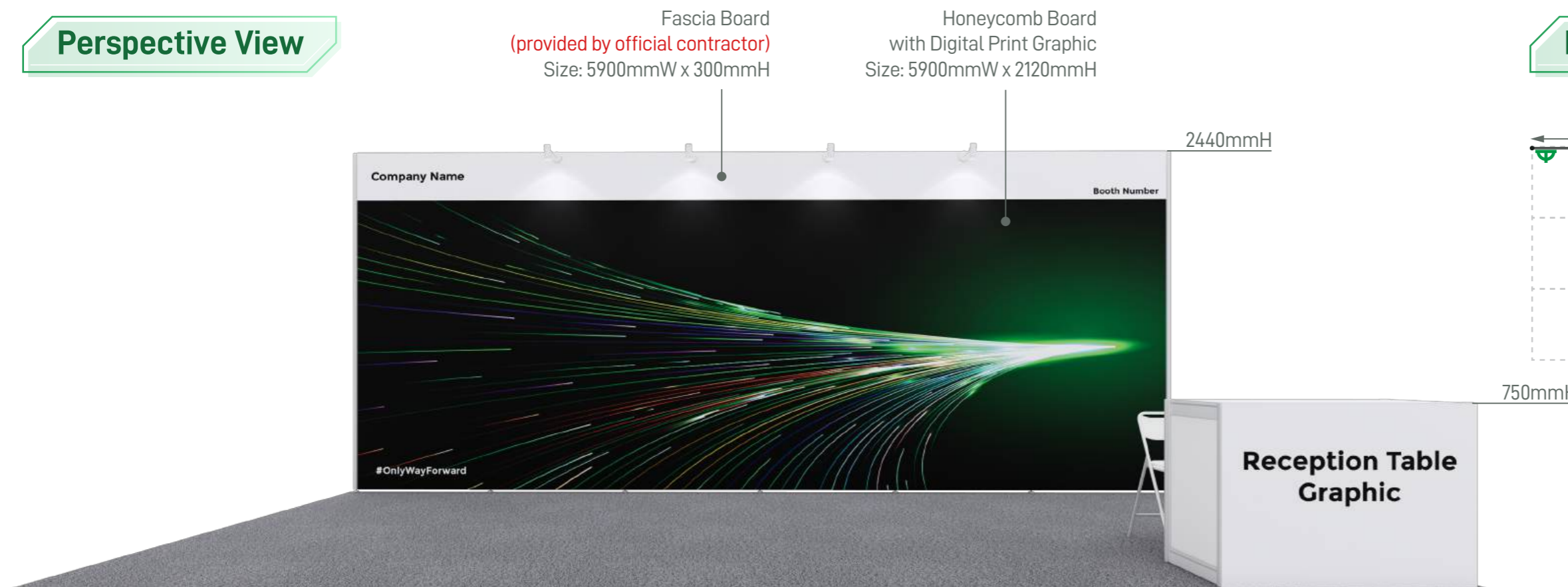

## Layout plan

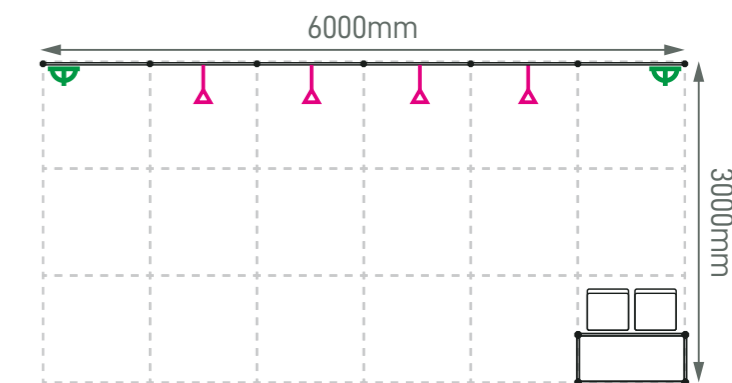

## Graphic Submission

Display Area / Graphic Size:  
5900mmW x 2120mmH

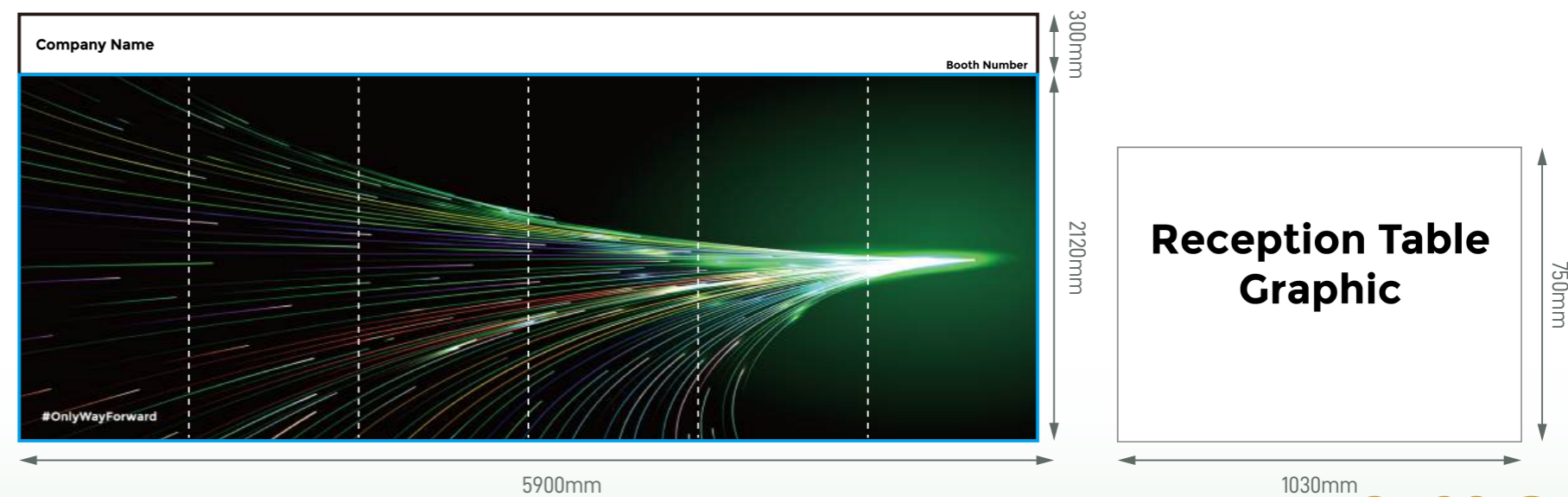

### Legend

### Qty

	LED Longarm Spotlight	4
	500W Square Pin Socket	2
	Reception Desk (1mW x 0.5mD x 0.75mH)	1
	Folding Chair	2

Revised Date: 27 May 2026 (V05)

# Standard Booth (J2L) - 6m x 3m

Size: 6000mmL x 3000mmD x 2440mmH

( Left opened )



10-11 SEPTEMBER 2026 | HONG KONG  
ASIA'S HUB FOR CLIMATE ACTION & SUSTAINABLE BUSINESS SOLUTIONS

## Perspective View

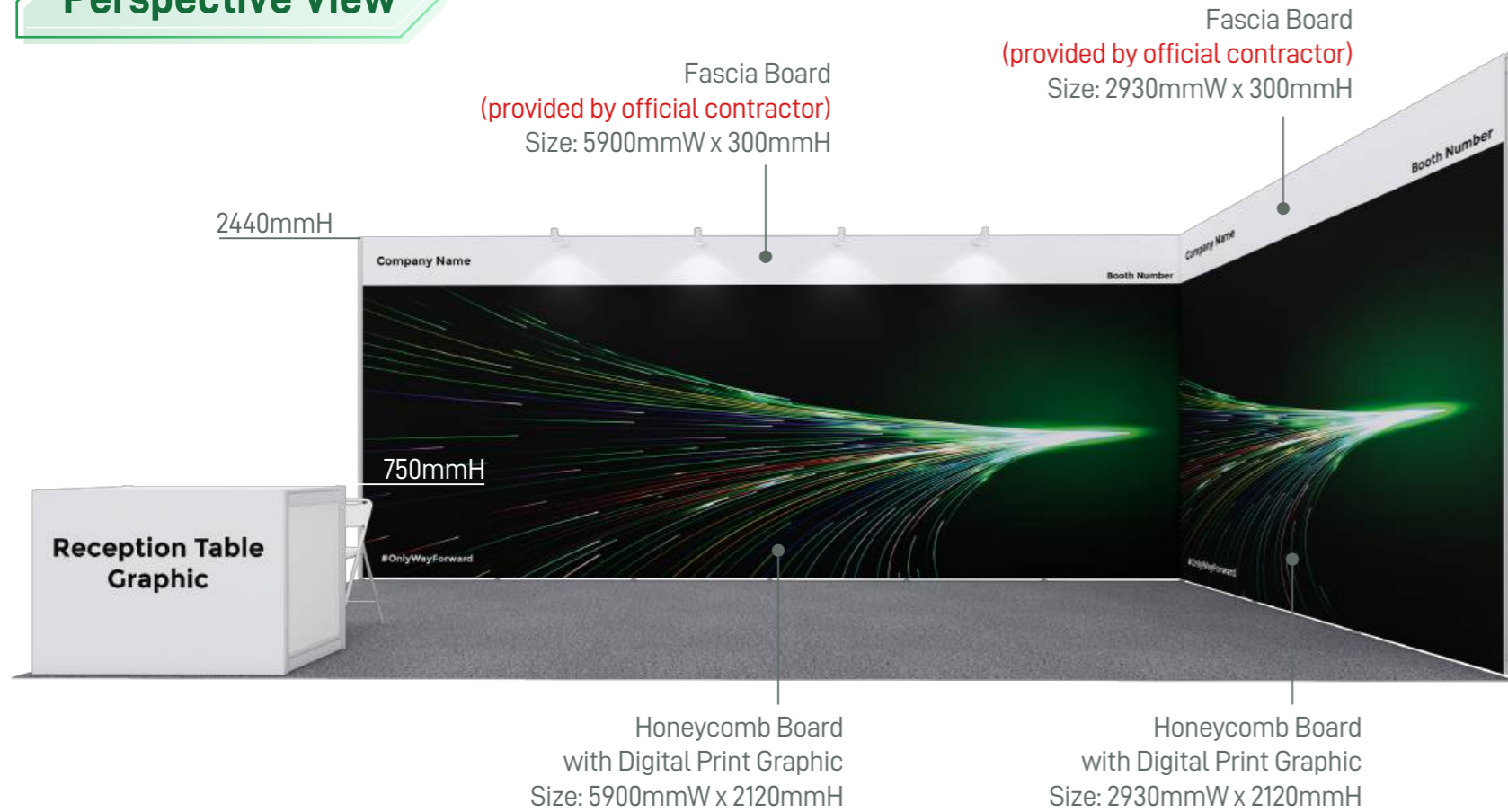

## Layout plan

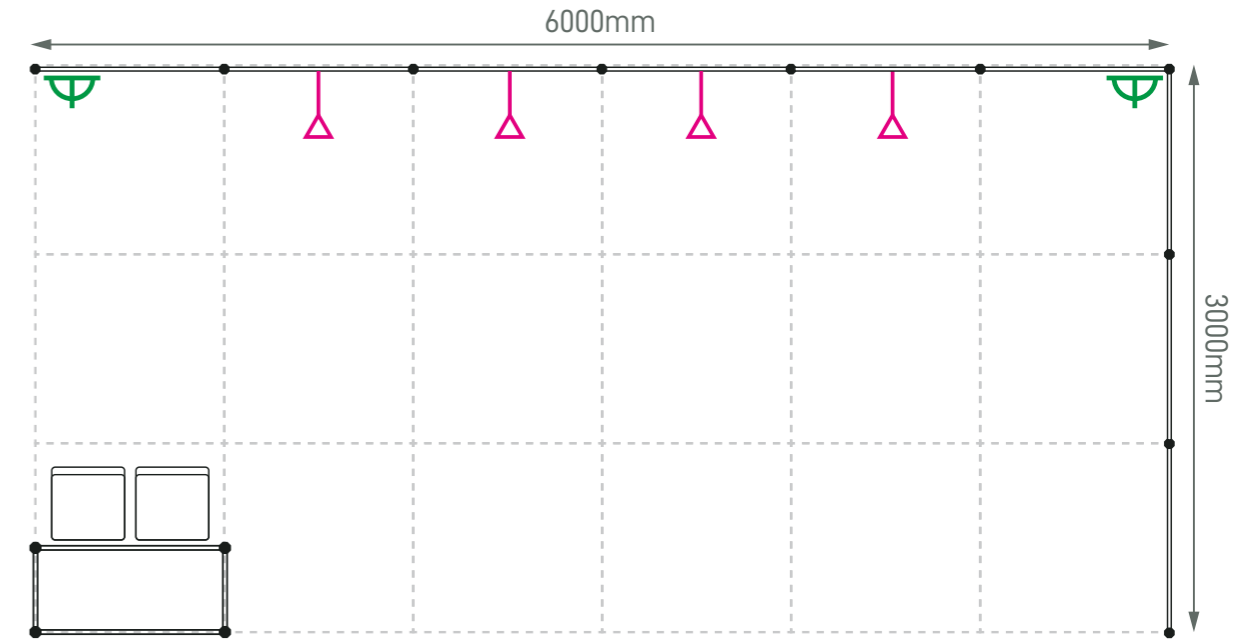

## Graphic Submission

Display Area / Graphic Size:  
2930mmW x 2120mmH

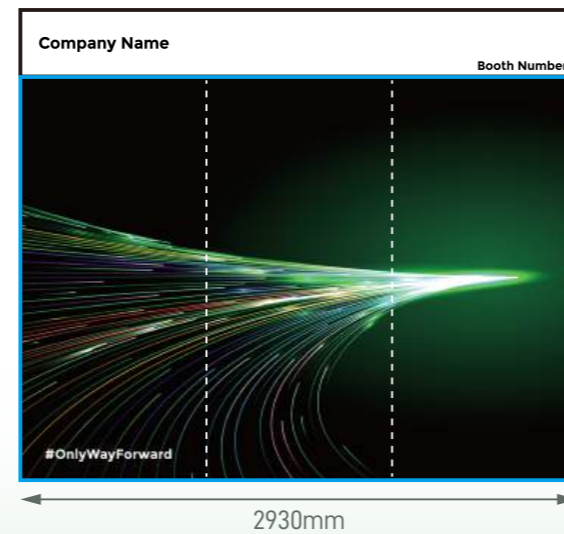

Display Area / Graphic Size:  
5900mmW x 2120mmH

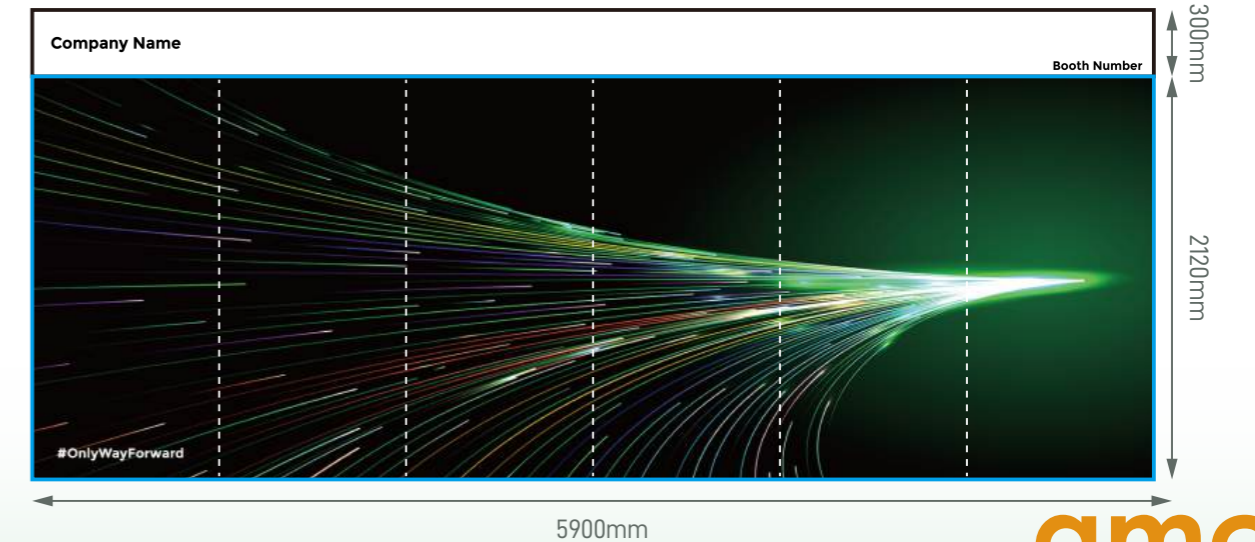

### Legend

Legend	Qty
	LED Longarm Spotlight 4
	500W Square Pin Socket 2
	Reception Desk (1mW x 0.5mD x 0.75mH) 1
	Folding Chair 2

Revised Date: 27 May 2026 (V05)

# Standard Booth (J2R) - 6m x 3m

Size: 6000mmL x 3000mmD x 2440mmH

( Right opened )



10-11 SEPTEMBER 2026 | HONG KONG  
ASIA'S HUB FOR CLIMATE ACTION & SUSTAINABLE BUSINESS SOLUTIONS

## Perspective View

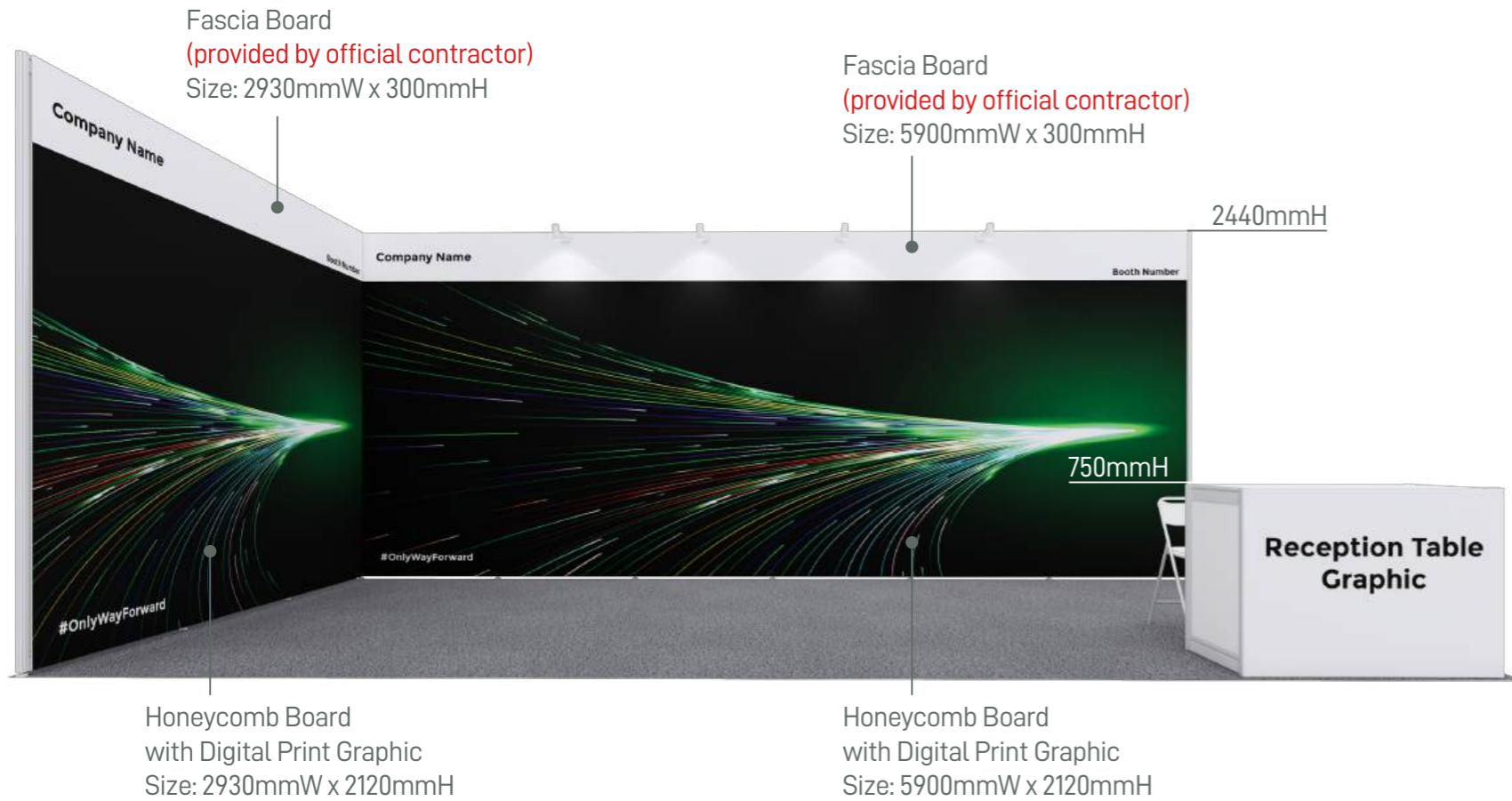

## Layout plan

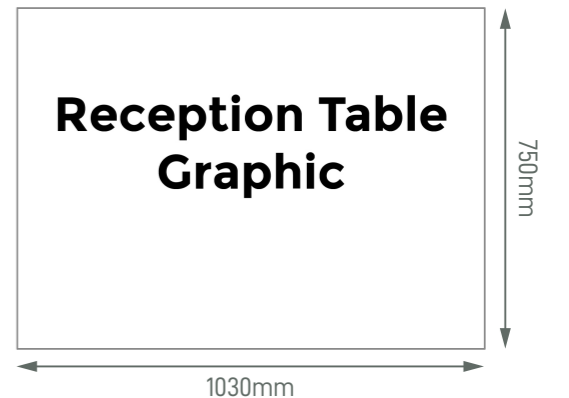

## Graphic Submission

Display Area / Graphic Size:  
2930mmW x 2120mmH

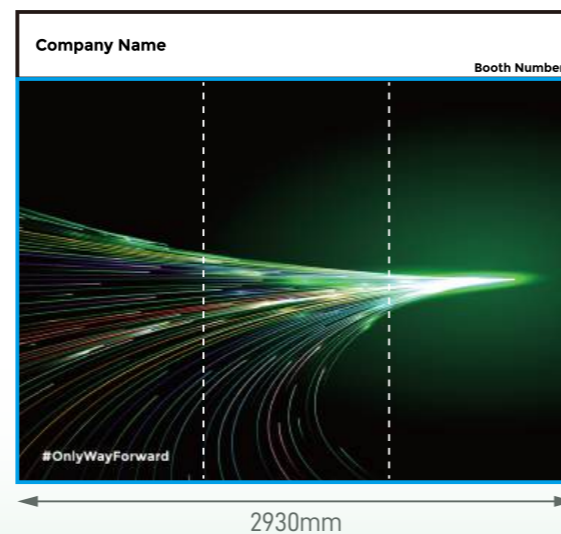

Display Area / Graphic Size:  
5900mmW x 2120mmH

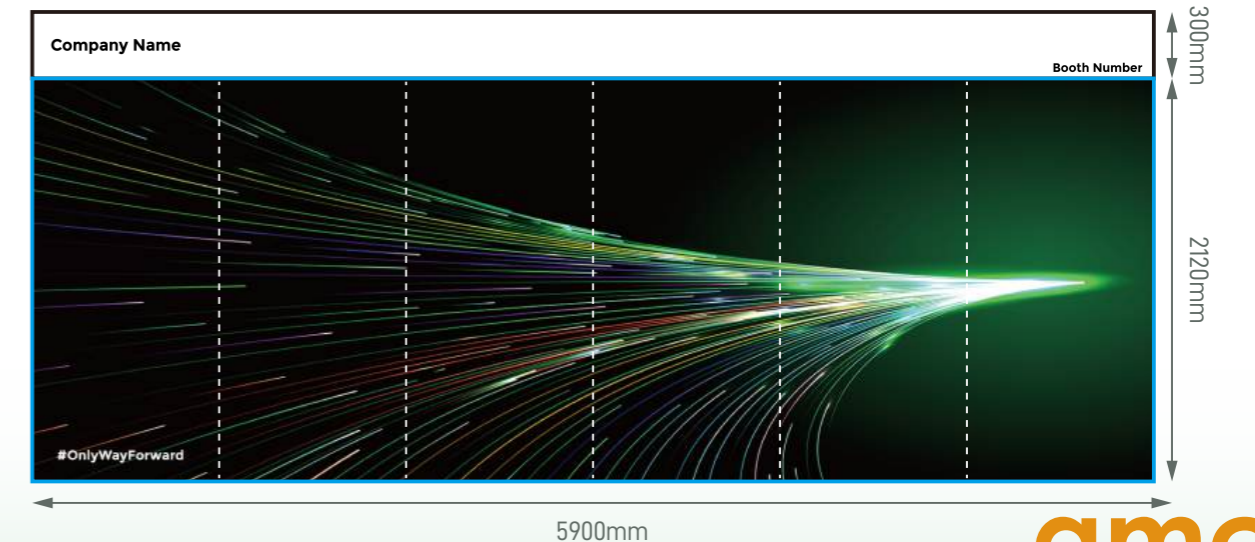

Legend	Qty
	LED Longarm Spotlight 4
	500W Square Pin Socket 2
	Reception Desk (1mW x 0.5mD x 0.75mH) 1
	Folding Chair 2

Revised Date: 27 May 2026 (V05)



# Standard Booth (K) - 4m x 5m

Size: 4000mmL x 5000mmD x 2440mmH



10-11 SEPTEMBER 2026 | HONG KONG  
ASIA'S HUB FOR CLIMATE ACTION & SUSTAINABLE BUSINESS SOLUTIONS

## Perspective View

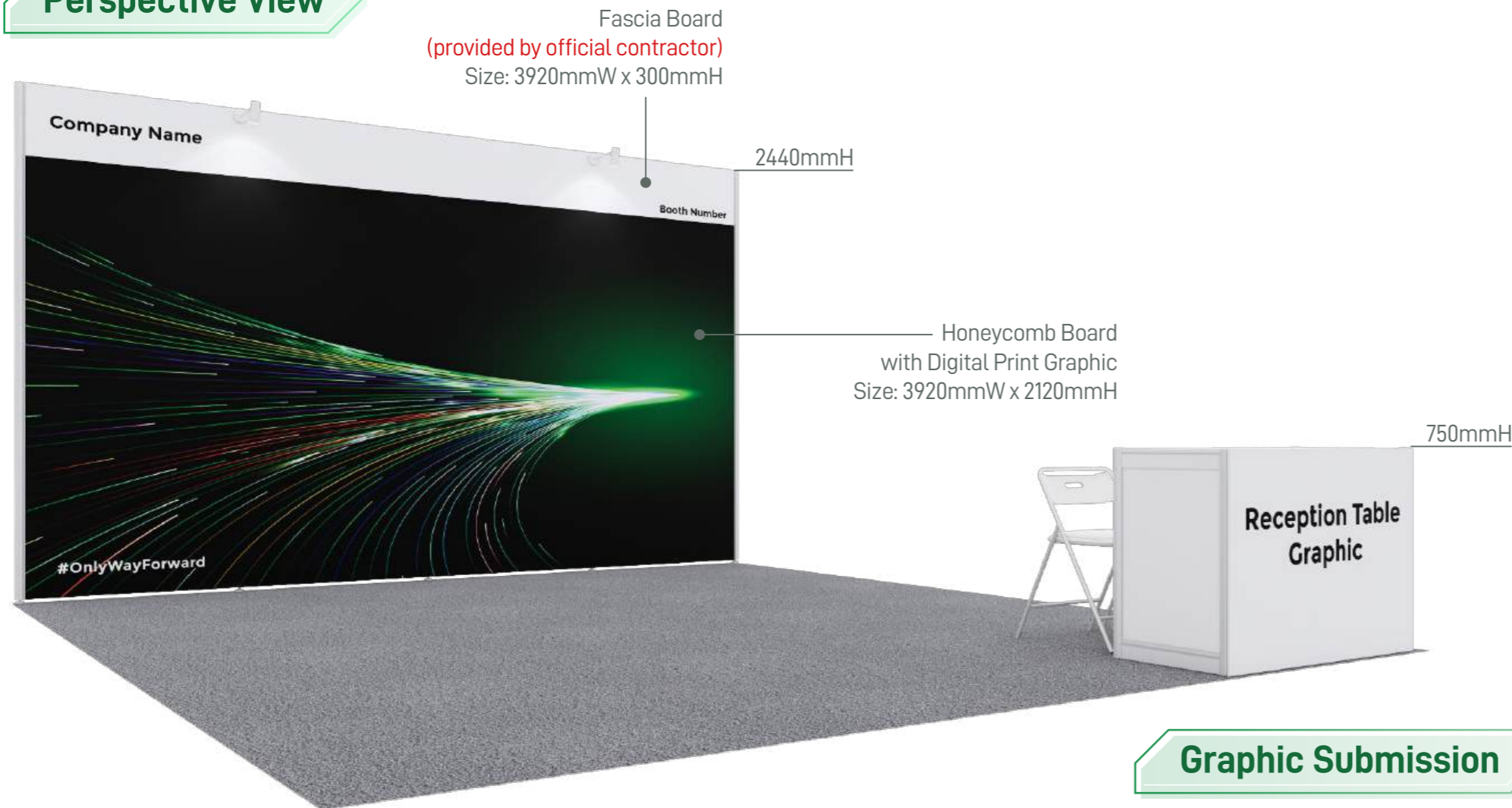

## Layout plan

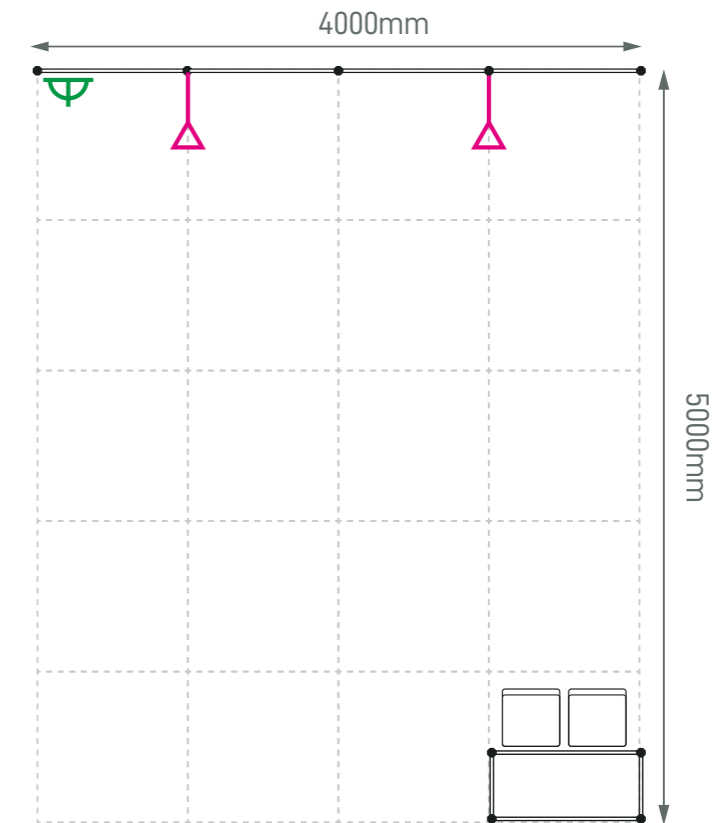

## Graphic Submission

Display Area / Graphic Size:  
3920mmW x 2120mmH

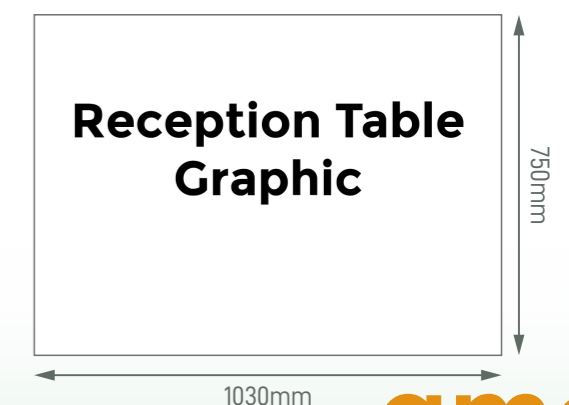
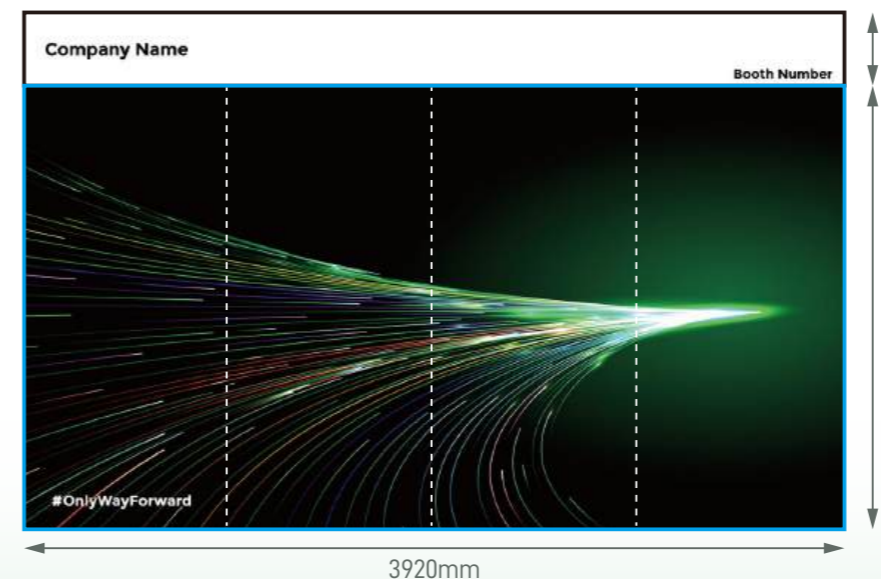

### Legend

### Qty

	LED Longarm Spotlight	2
	500W Square Pin Socket	1
	Reception Desk (1mW x 0.5mD x 0.75mH)	1
	Folding Chair	2

Revised Date: 27 May 2026 (V05)

# Standard Booth (K1) - 5m x 4m

Size: 5000mmL x 4000mmD x 2440mmH



10-11 SEPTEMBER 2026 | HONG KONG  
ASIA'S HUB FOR CLIMATE ACTION & SUSTAINABLE BUSINESS SOLUTIONS

## Perspective View

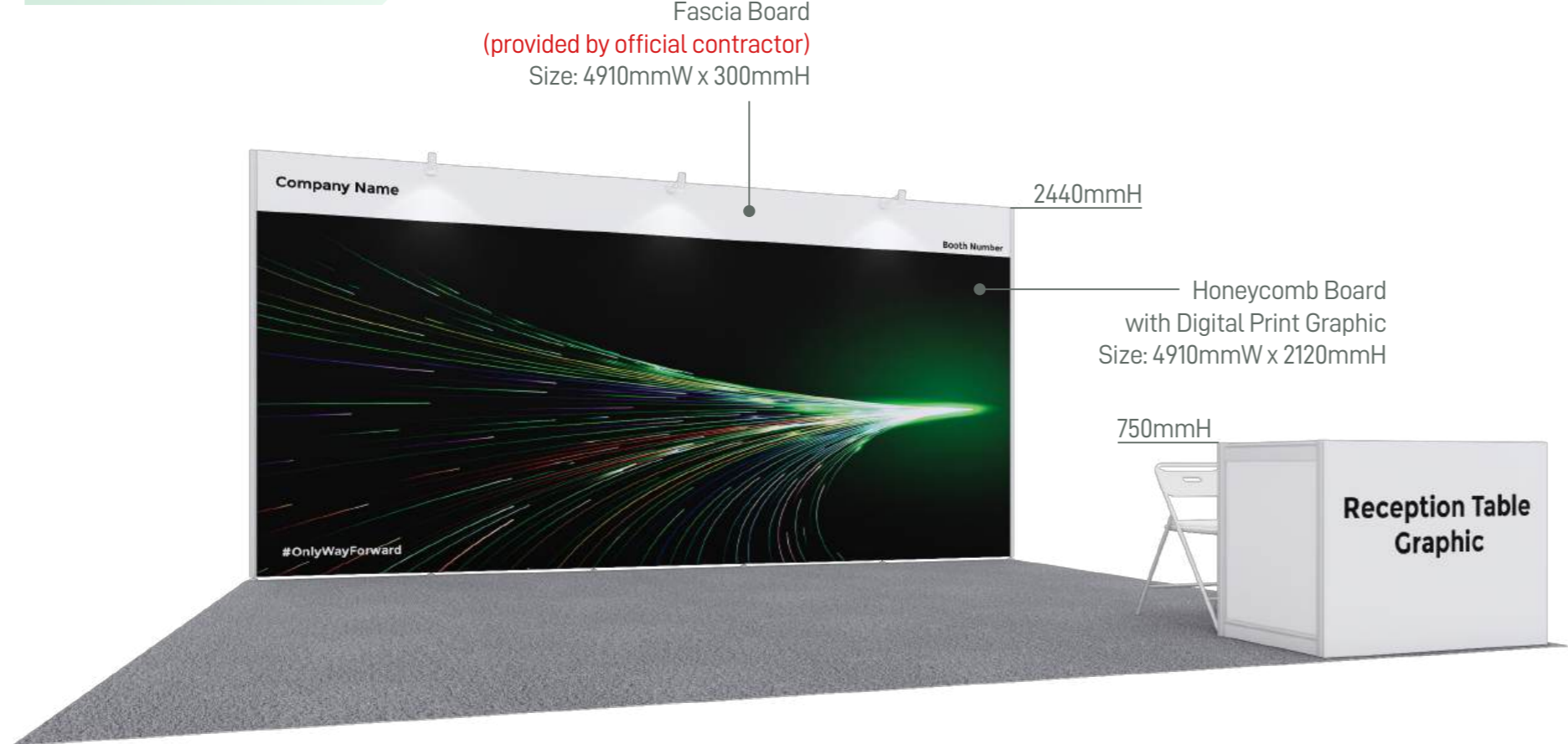

## Layout plan

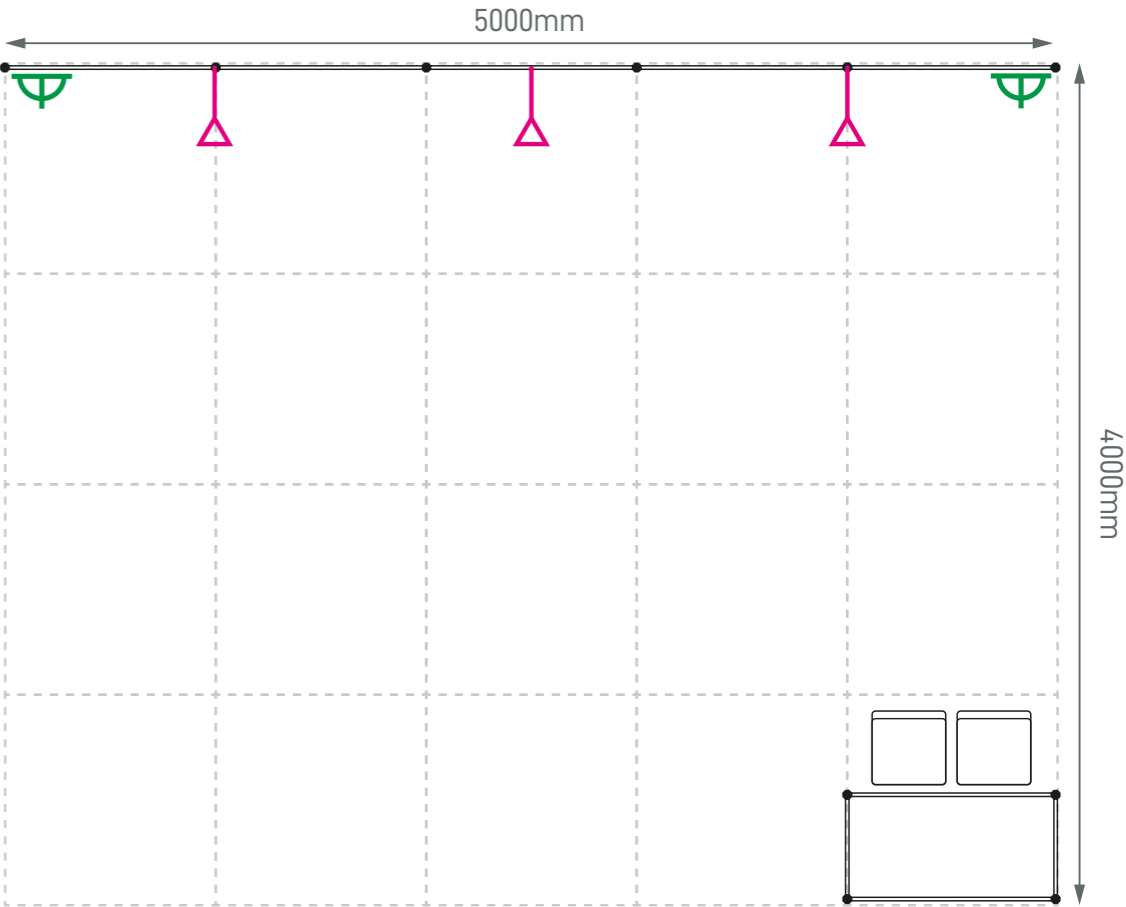

## Graphic Submission

Display Area / Graphic Size:  
4910mmW x 2120mmH

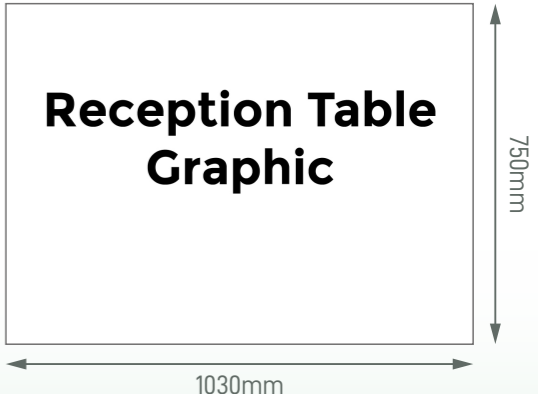
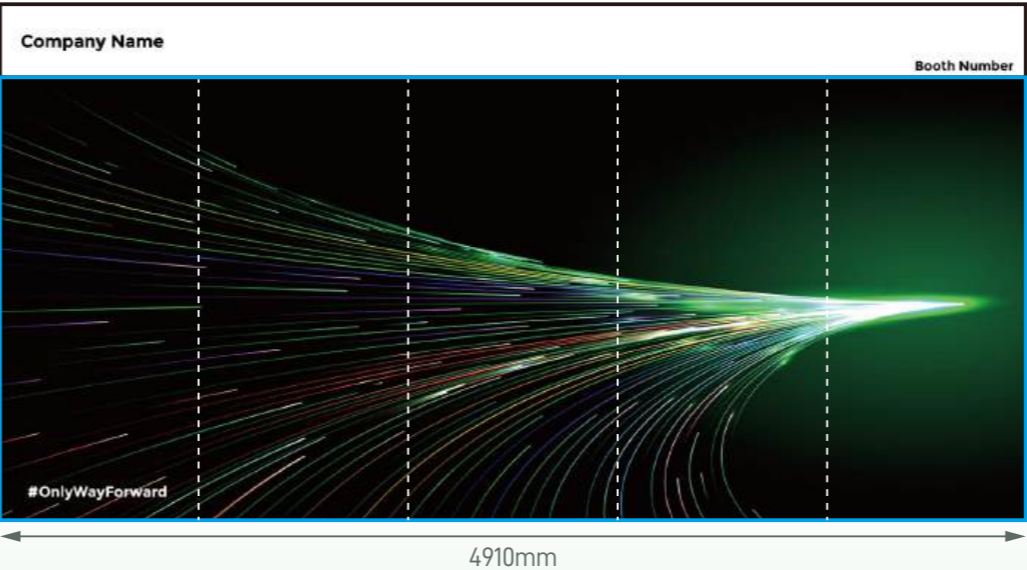

Legend	Qty
	LED Longarm Spotlight 3
	500W Square Pin Socket 2
	Reception Desk (1mW x 0.5mD x 0.75mH) 1
	Folding Chair 2

Revised Date: 27 May 2026 (V05)



# Standard Booth (M) - 7m x 3m

Size: 7000mmL x 3000mmD x 2440mmH



10-11 SEPTEMBER 2026 | HONG KONG  
ASIA'S HUB FOR CLIMATE ACTION & SUSTAINABLE BUSINESS SOLUTIONS

## Perspective View

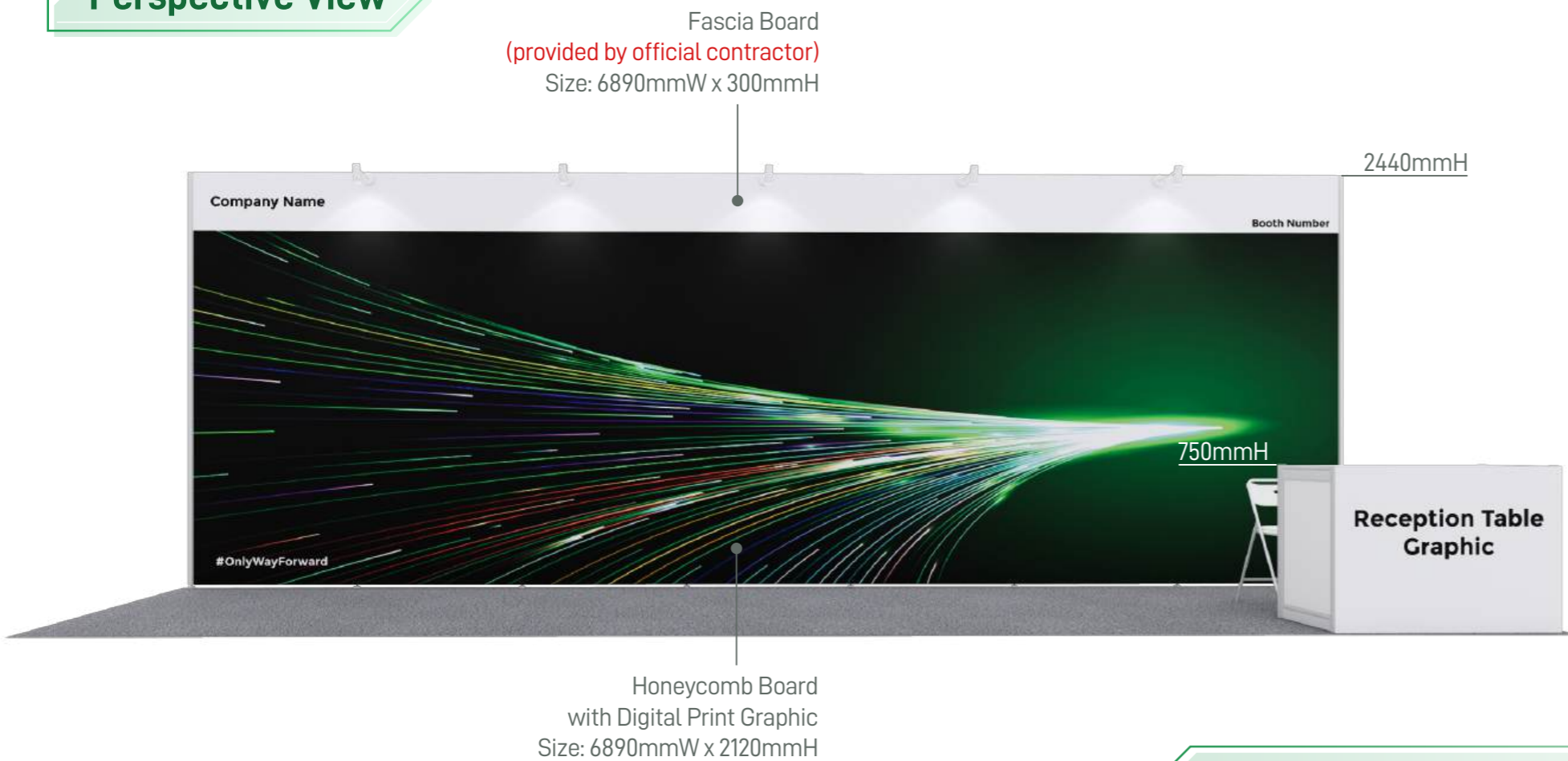

## Layout plan

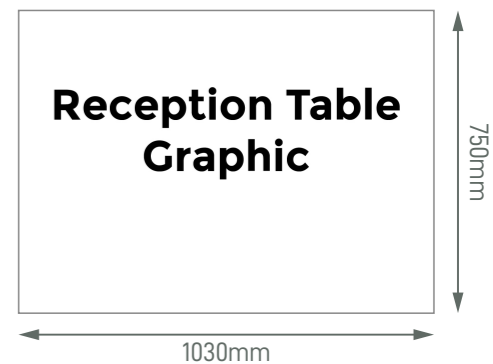
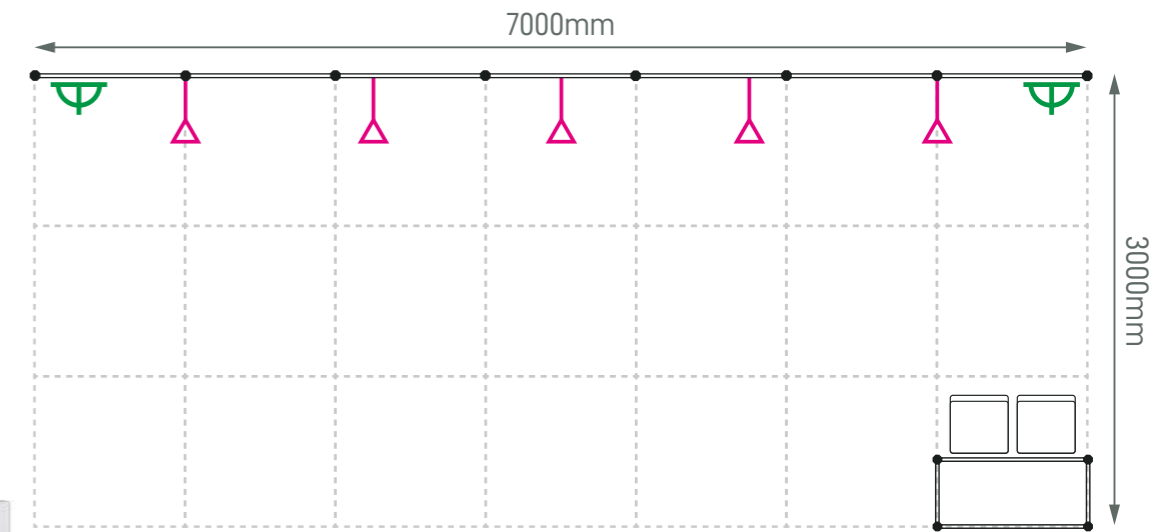

## Graphic Submission

Display Area / Graphic Size:  
6890mmW x 2120mmH

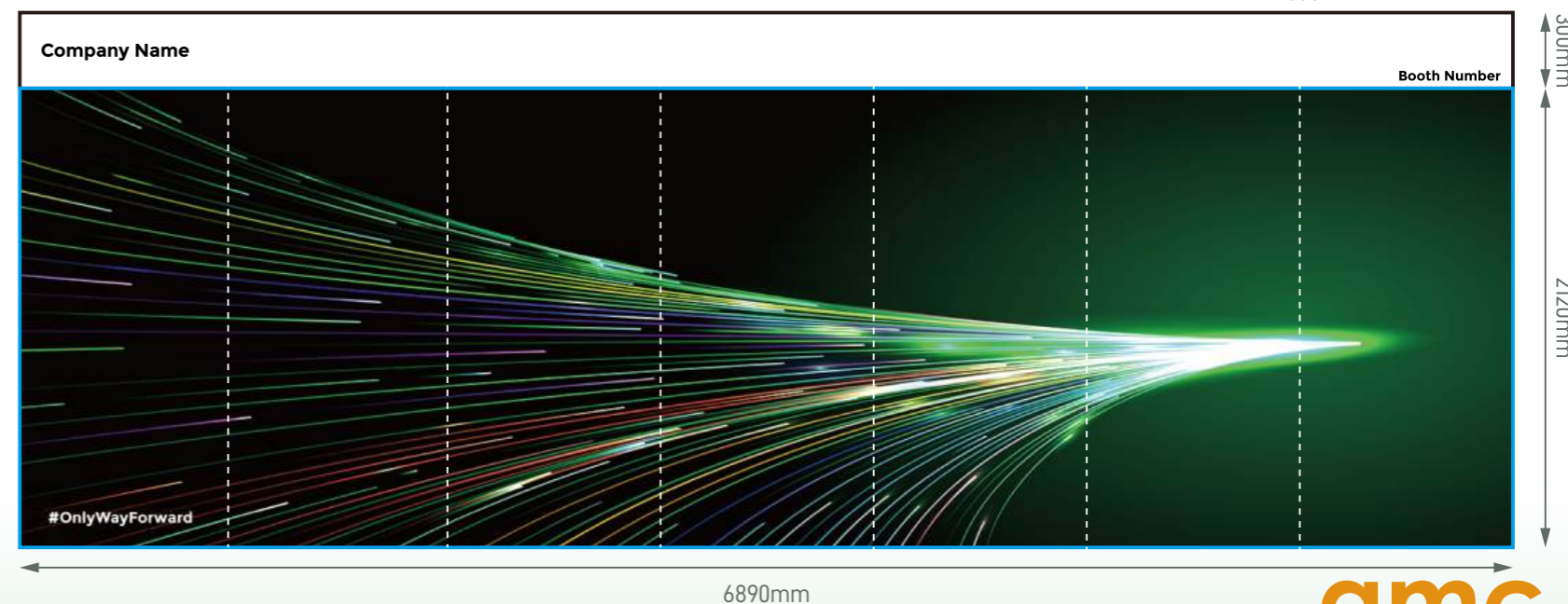

### Legend

	Qty
	5
	2
	1
	2

Revised Date: 27 May 2026 (V05)

# Standard Booth (N1) - 4m x 6m

Size: 4000mmL x 6000mmD x 2440mmH



10-11 SEPTEMBER 2026 | HONG KONG  
ASIA'S HUB FOR CLIMATE ACTION & SUSTAINABLE BUSINESS SOLUTIONS

## Perspective View

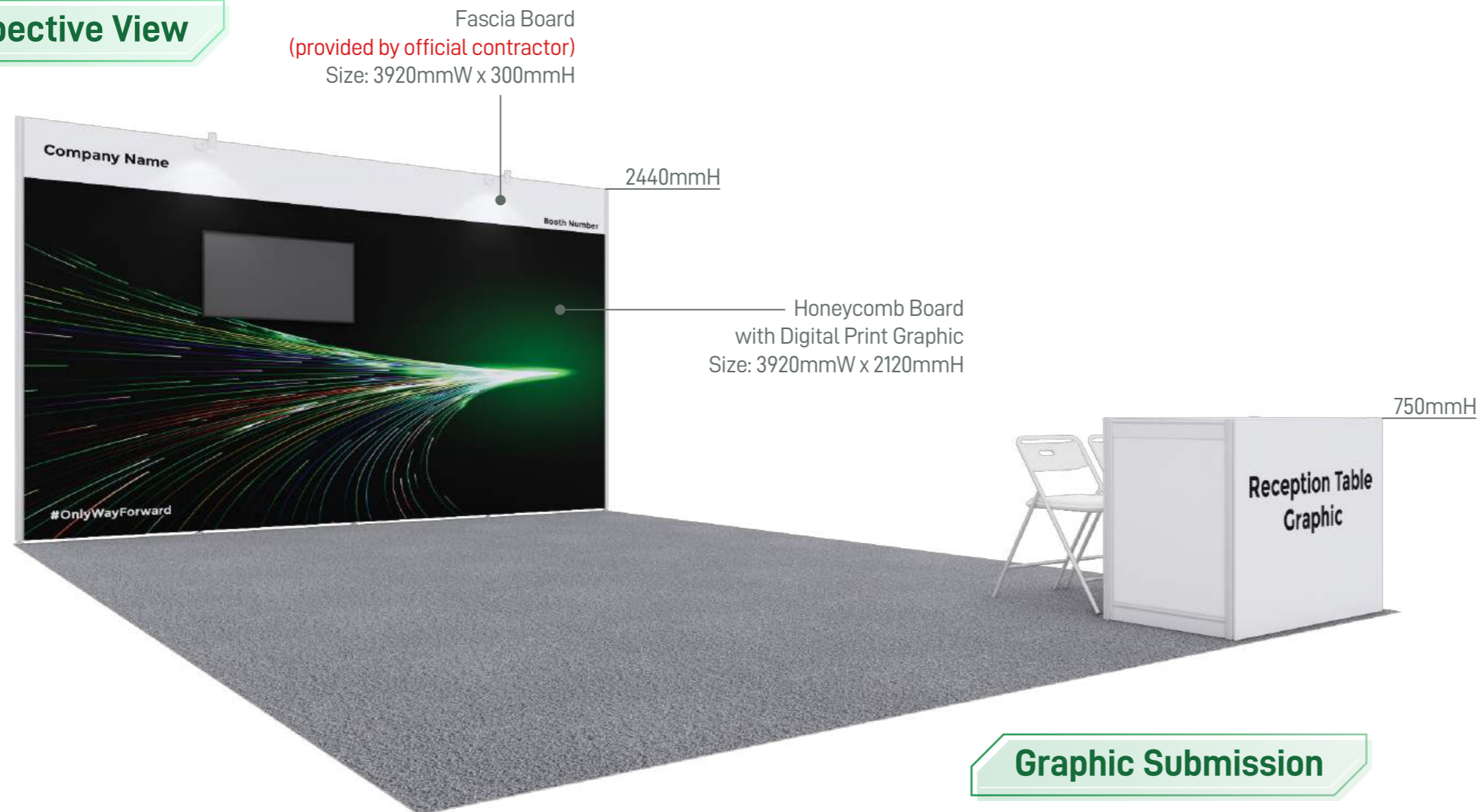

## Layout plan

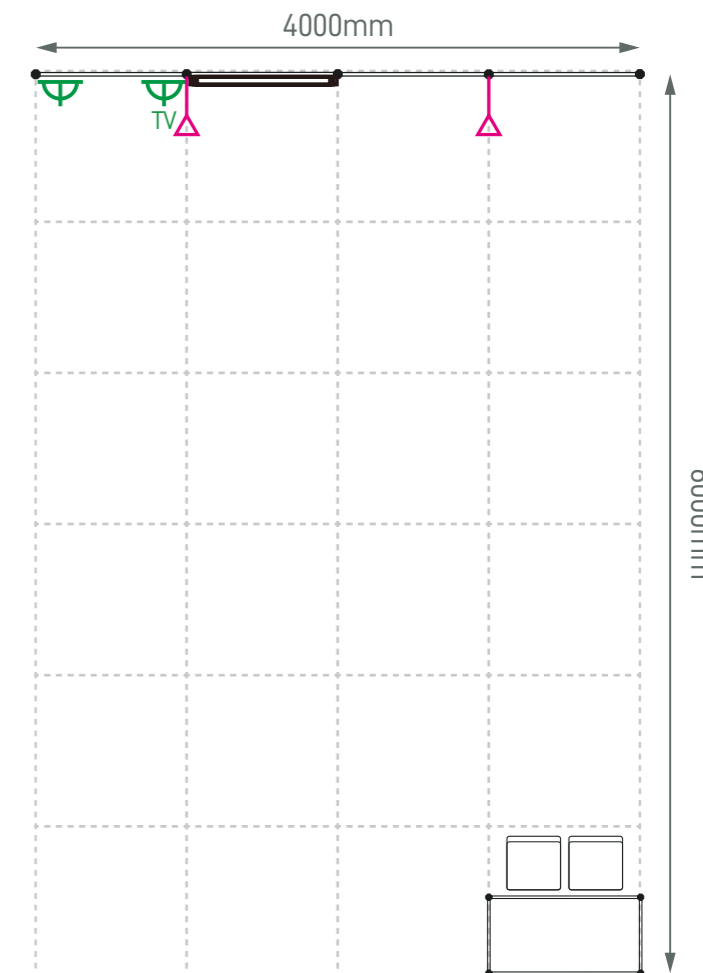

## Graphic Submission

Display Area / Graphic Size:  
3920mmW x 2120mmH

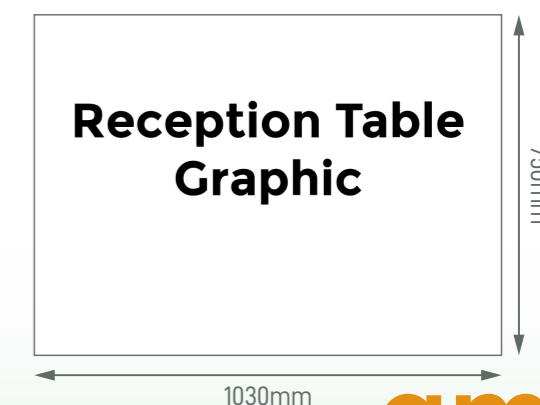
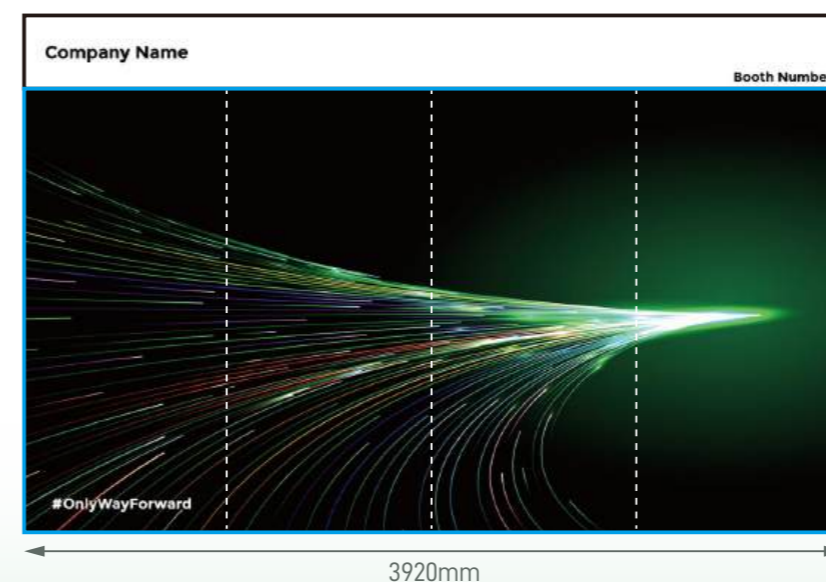

Legend	Qty
	LED Longarm Spotlight 2
	500W Square Pin Socket 1
	Reception Desk (1mW x 0.5mD x 0.75mH) 1
	Folding Chair 2
	43" LED TV 1
	Socket for LED TV 1

Revised Date: 27 May 2026 (V05)

# Standard Booth (N2) - 6m x 4m

Size: 6000mmL x 4000mmD x 2440mmH



10-11 SEPTEMBER 2026 | HONG KONG  
ASIA'S HUB FOR CLIMATE ACTION & SUSTAINABLE BUSINESS SOLUTIONS

## Perspective View

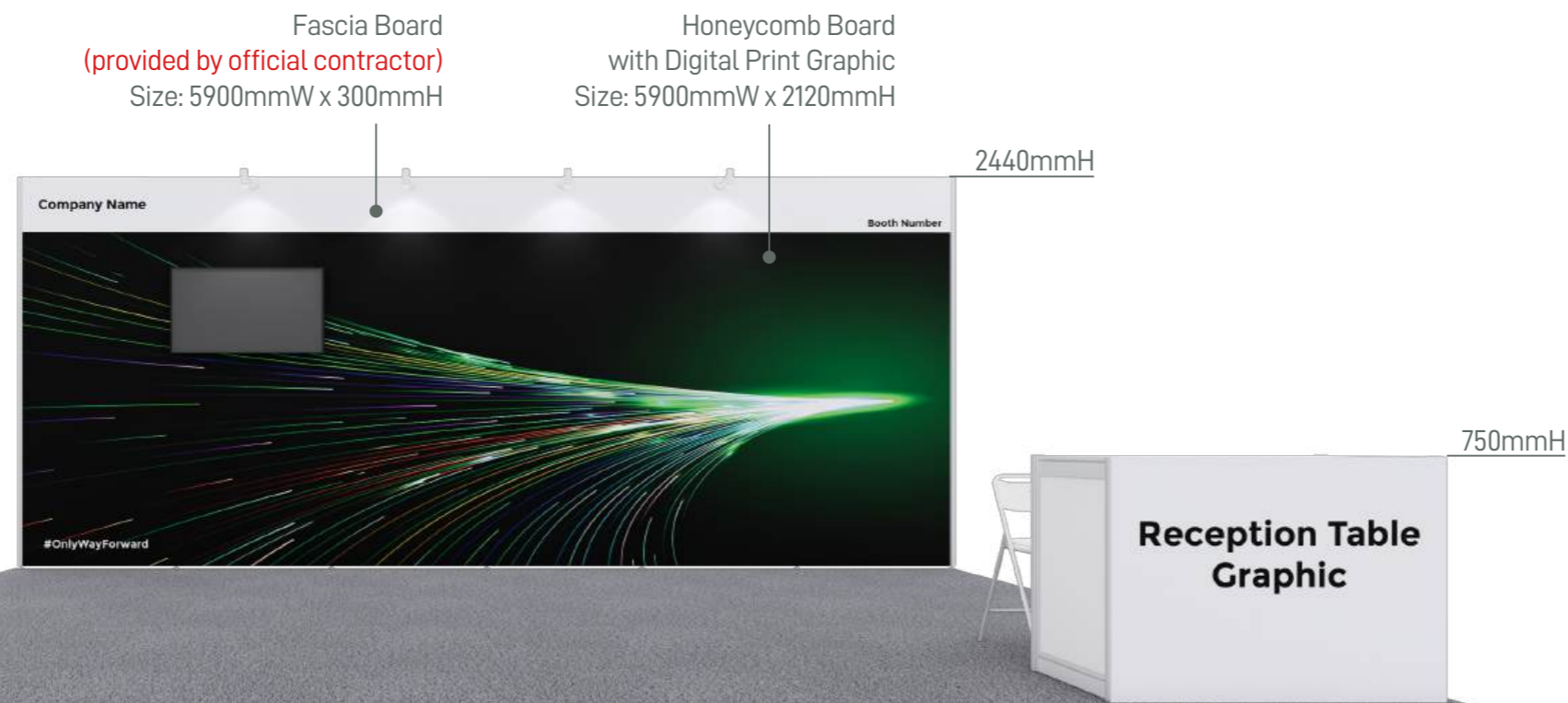

## Layout plan

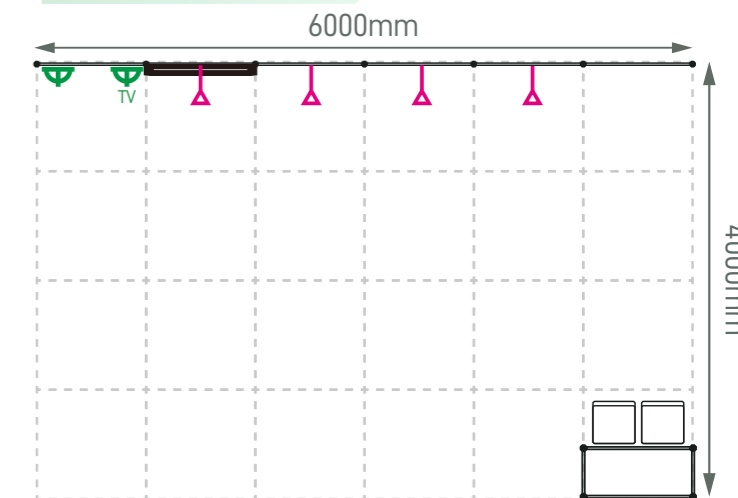

## Graphic Submission

Display Area / Graphic Size:  
5900mmW x 2120mmH

Legend	Qty
	LED Longarm Spotlight 4
	500W Square Pin Socket 1
	Reception Desk (1mW x 0.5mD x 0.75mH) 1
	Folding Chair 2
	43" LED TV 1
	Socket for LED TV 1

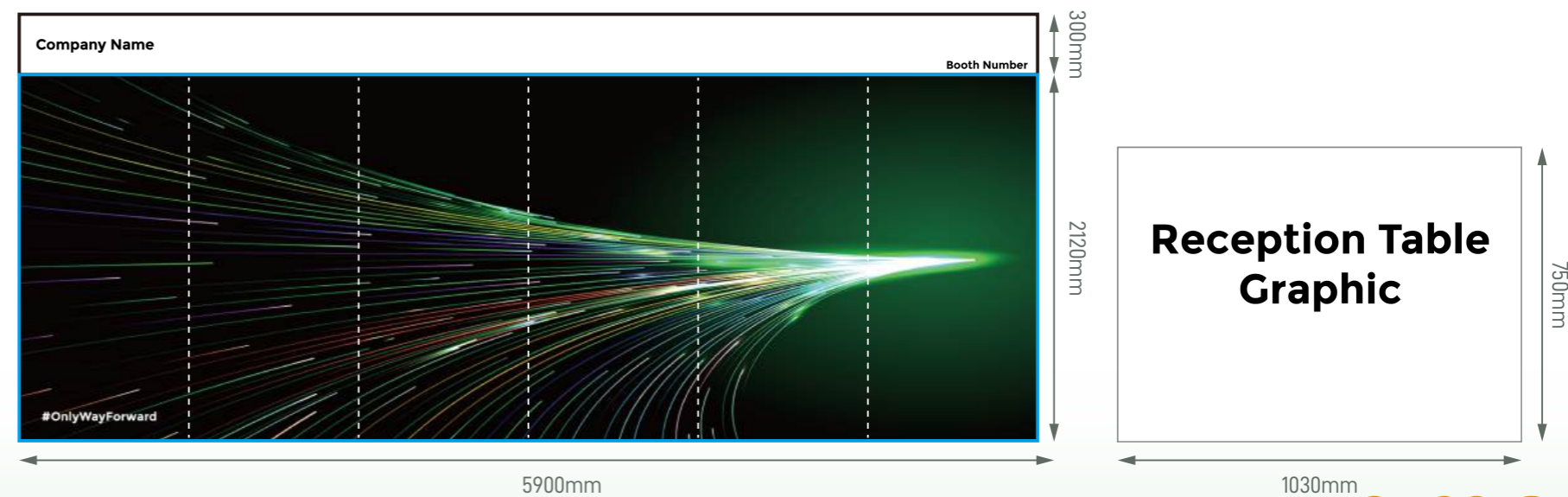

Revised Date: 27 May 2026 (V05)

# Standard Booth (N3) - 8m x 3m

Size: 8000mmL x 3000mmD x 2440mmH



10-11 SEPTEMBER 2026 | HONG KONG  
ASIA'S HUB FOR CLIMATE ACTION & SUSTAINABLE BUSINESS SOLUTIONS

## Perspective View

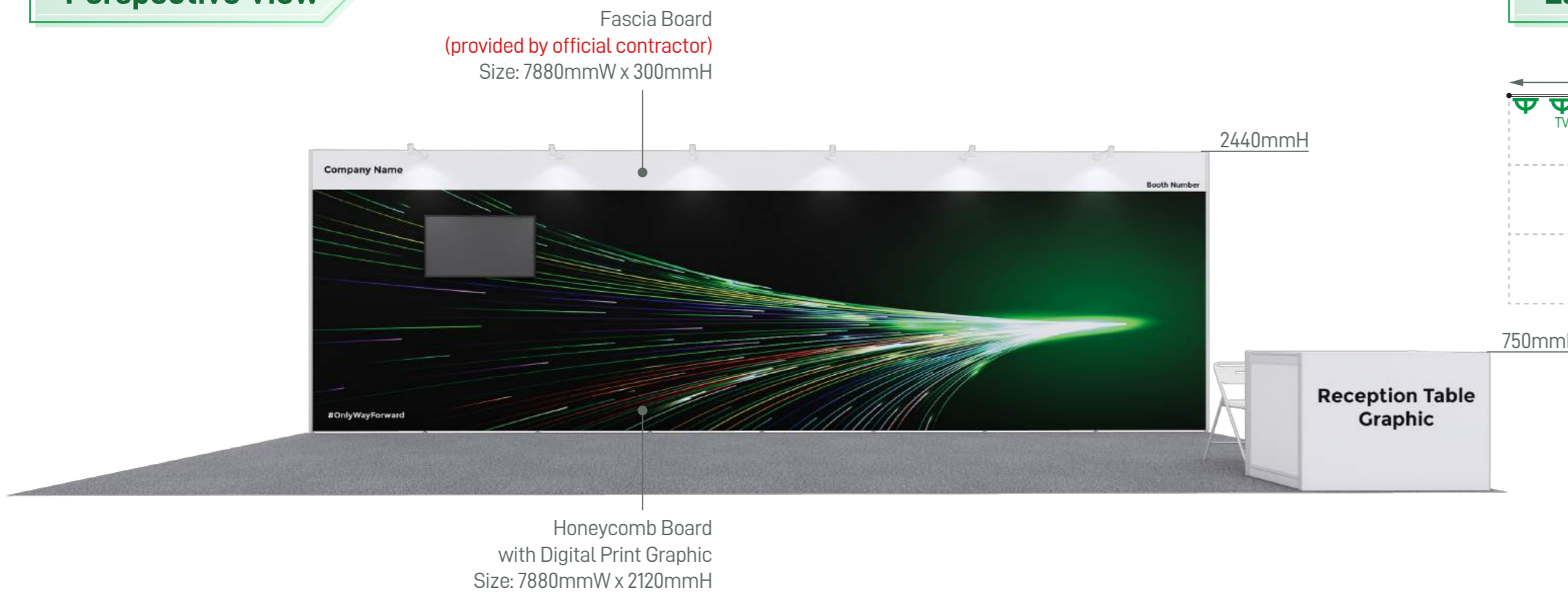

## Layout plan

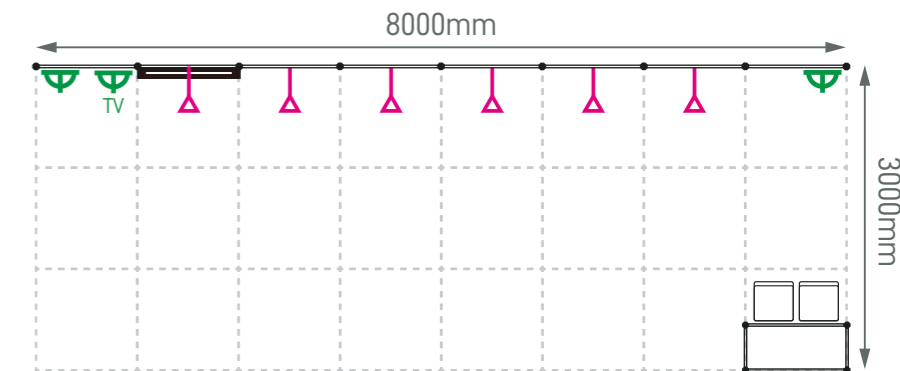

## Graphic Submission

Display Area / Graphic Size:  
7880mmW x 2120mmH

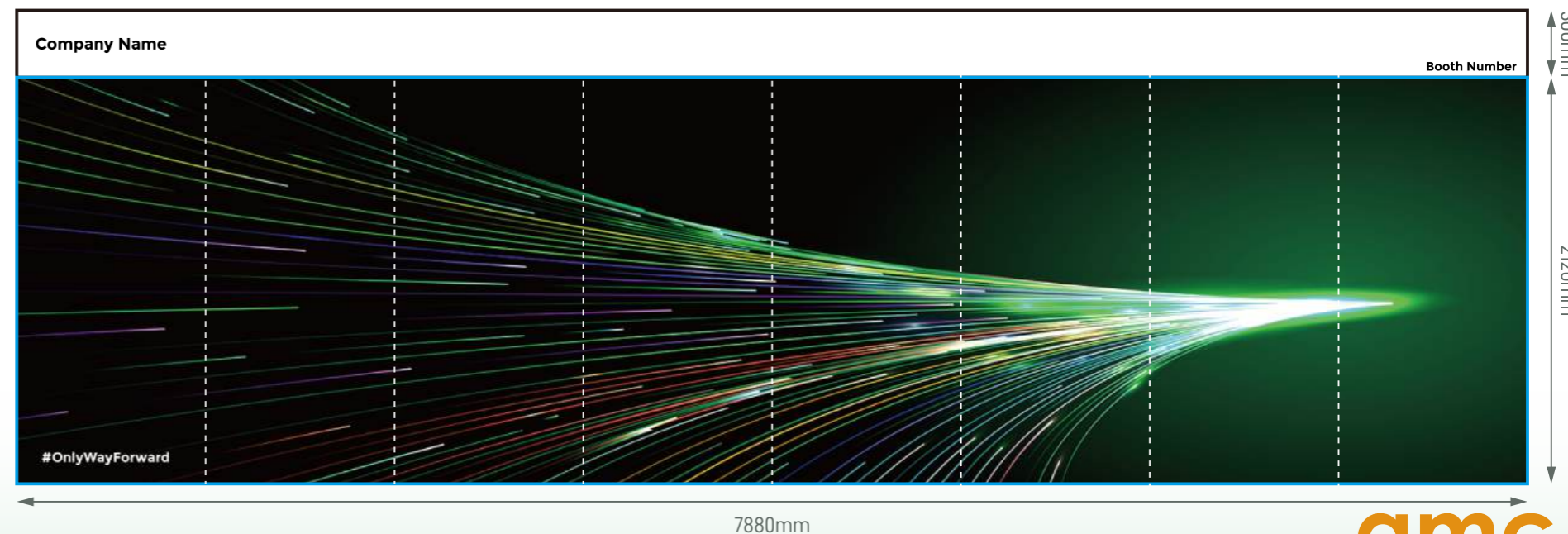

### Legend

Qty

	LED Longarm Spotlight	6
	500W Square Pin Socket	2
	Reception Desk (1mW x 0.5mD x 0.75mH)	1
	Folding Chair	2
	43" LED TV	1
	Socket for LED TV	1

Revised Date: 27 May 2026 (V05)

# Standard Booth (P) - 5m x 5m

Size: 5000mmL x 5000mmD x 2440mmH



10-11 SEPTEMBER 2026 | HONG KONG  
ASIA'S HUB FOR CLIMATE ACTION & SUSTAINABLE BUSINESS SOLUTIONS

## Perspective View

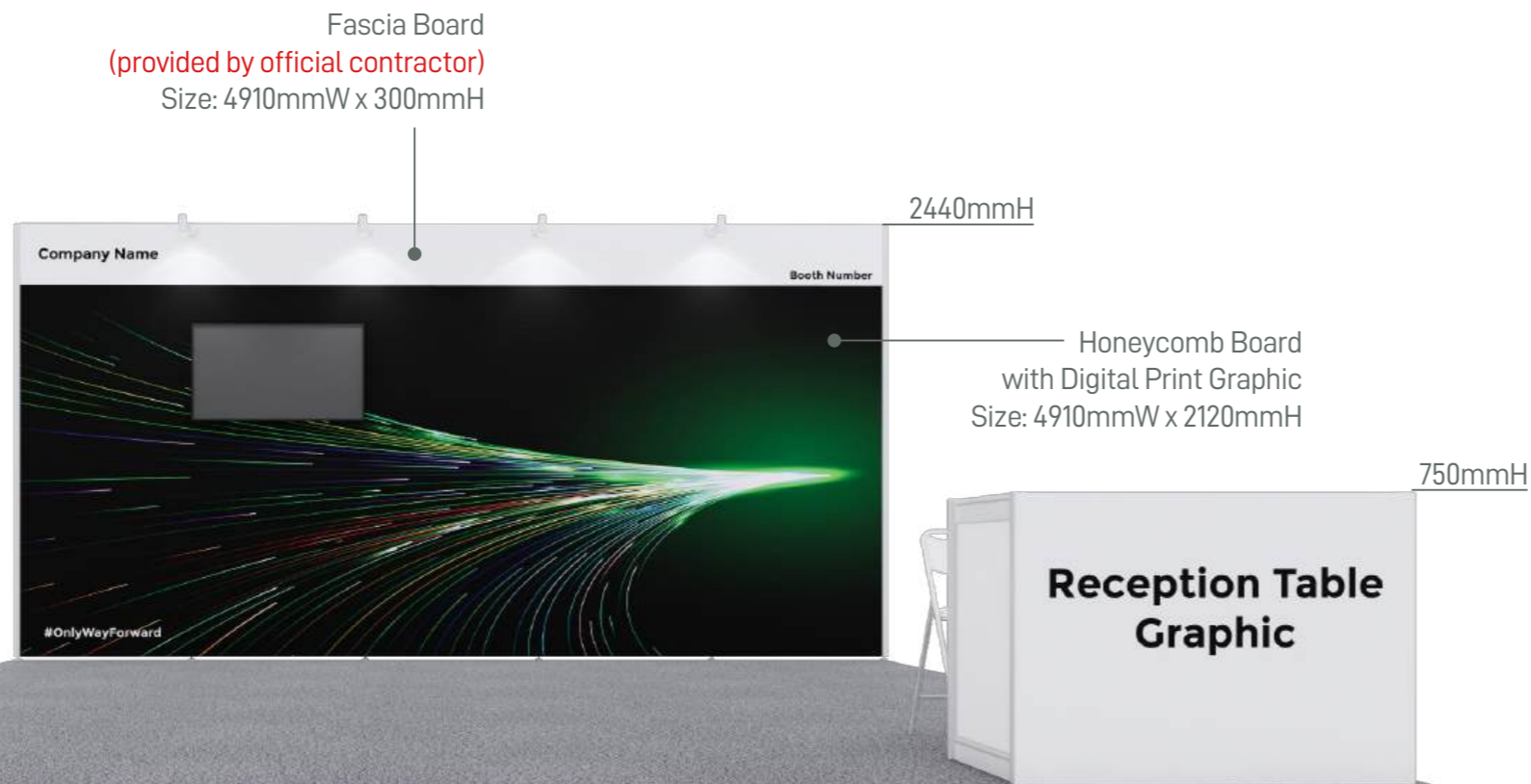

## Layout plan

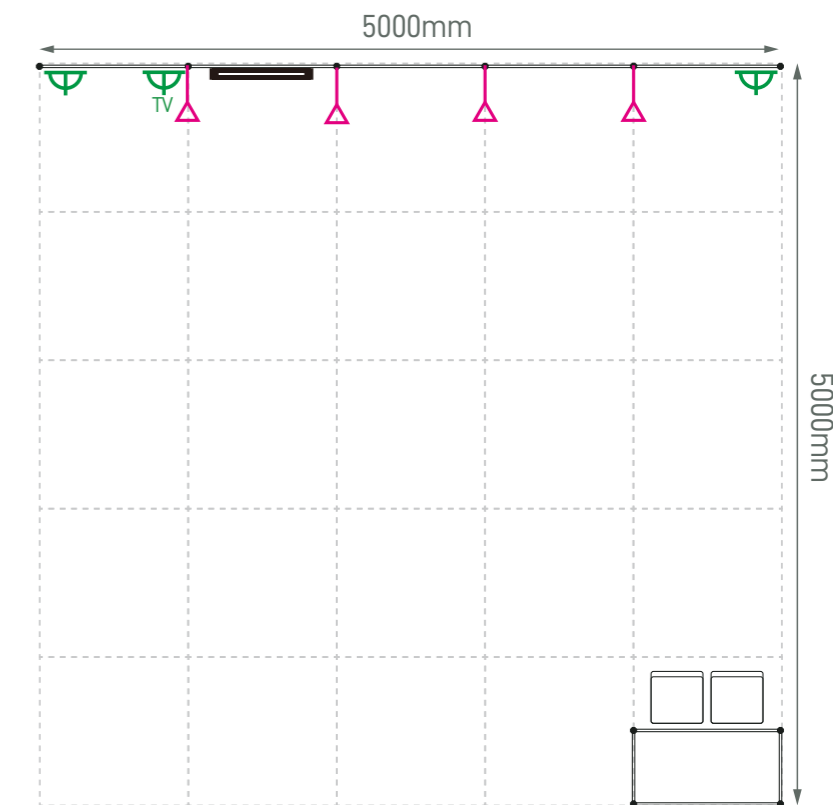

## Graphic Submission

Display Area / Graphic Size:  
4910mmW x 2120mmH

Legend	Qty
	LED Longarm Spotlight 4
	500W Square Pin Socket 2
	Reception Desk (1mW x 0.5mD x 0.75mH) 1
	Folding Chair 2
	43" LED TV 1
	Socket for LED TV 1

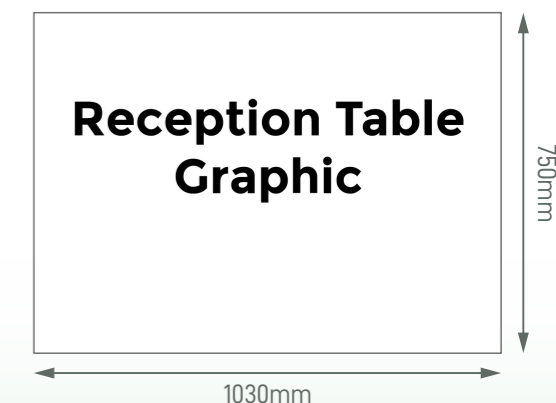
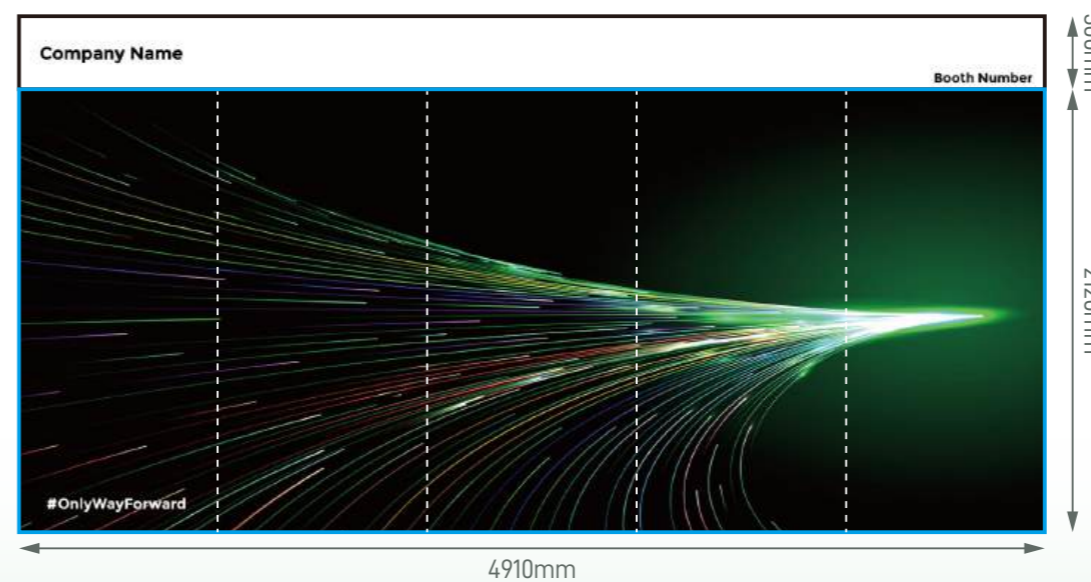

Revised Date: 27 May 2026 (V05)

# Standard Booth (Q) - 9m x 3m

Size: 9000mmL x 3000mmD x 2440mmH



10-11 SEPTEMBER 2026 | HONG KONG  
ASIA'S HUB FOR CLIMATE ACTION & SUSTAINABLE BUSINESS SOLUTIONS

## Perspective View

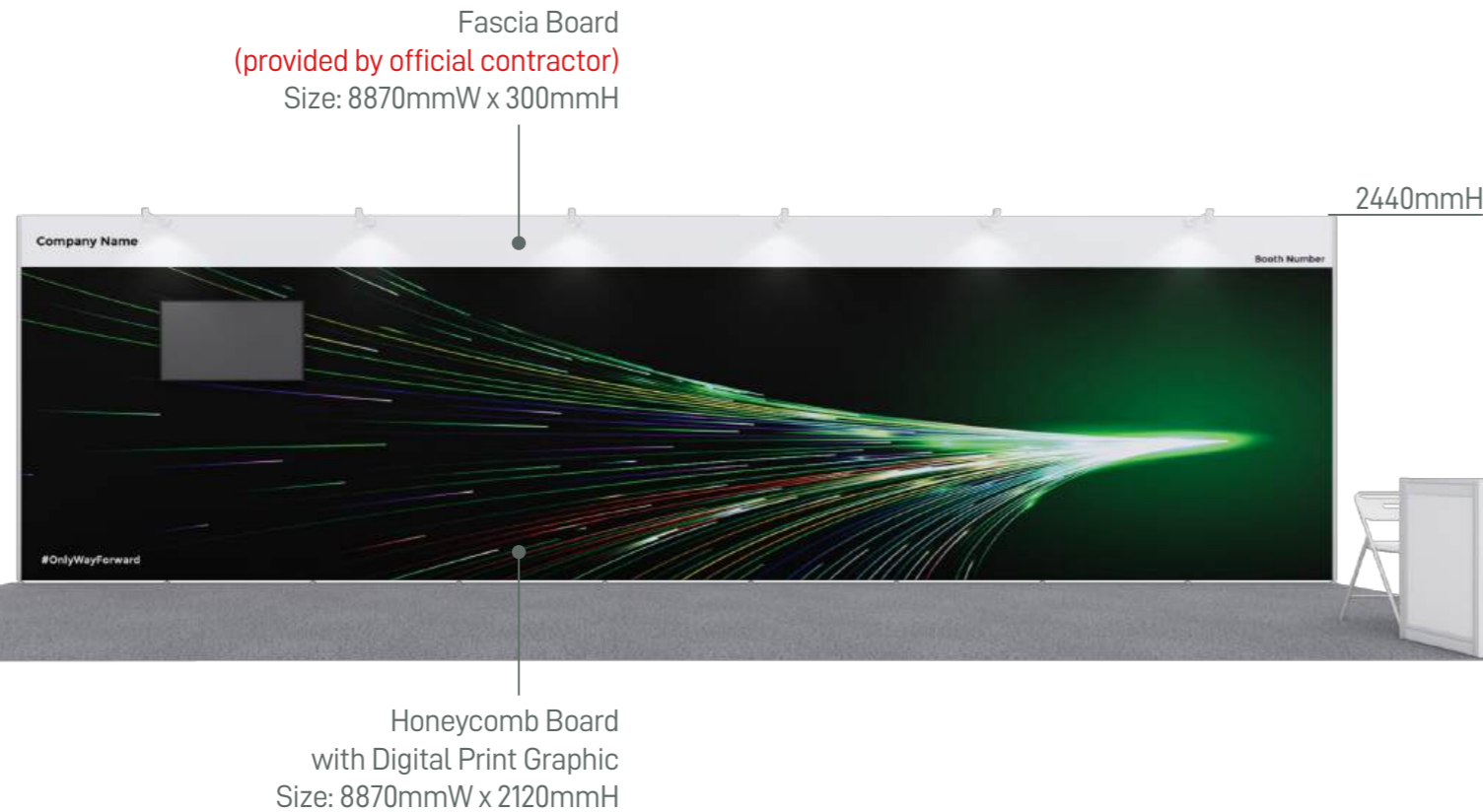

## Layout plan

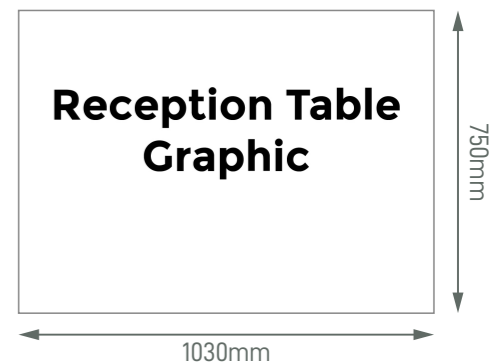
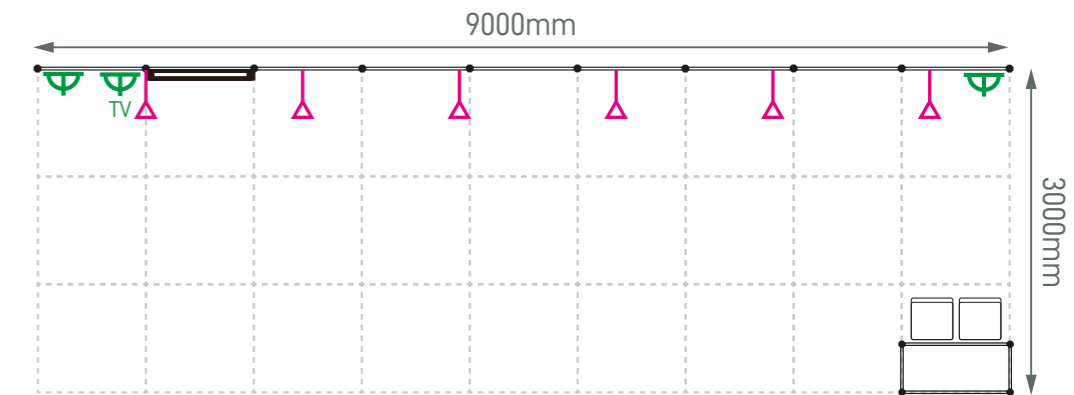

## Graphic Submission

Display Area / Graphic Size:  
8870mmW x 2120mmH

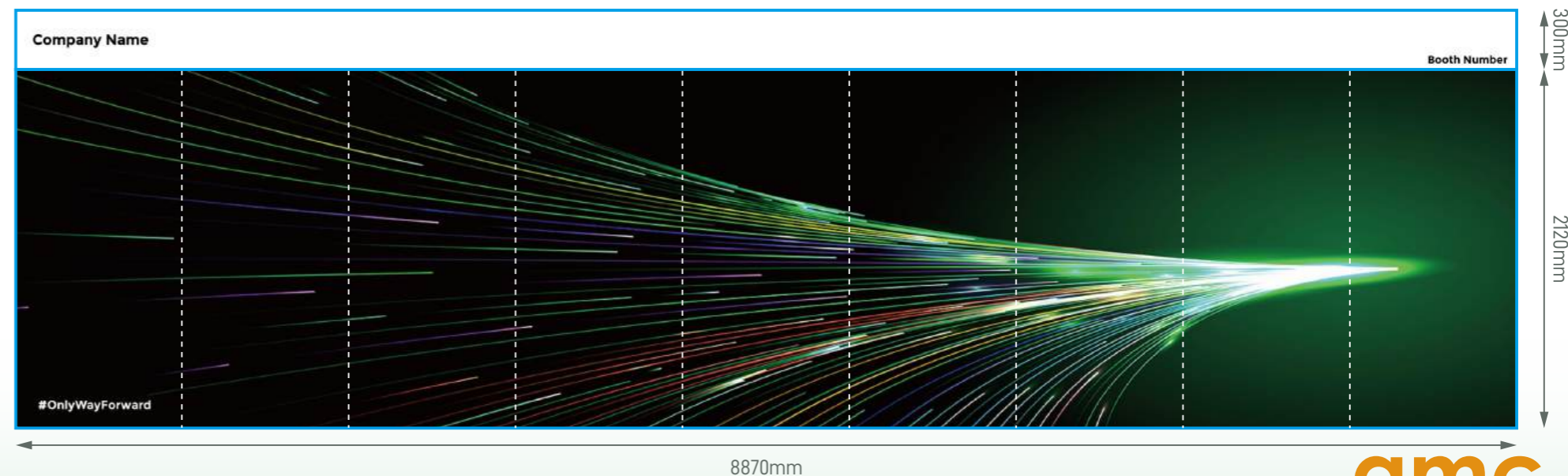

### Legend

Qty

	LED Longarm Spotlight	6
	500W Square Pin Socket	2
	Reception Desk (1mW x 0.5mD x 0.75mH)	1
	Folding Chair	2
	43" LED TV	1
	Socket for LED TV	1

Revised Date: 27 May 2026 (V05)

# Standard Booth (R1) - 5m x 6m

Size: 5000mmL x 6000mmD x 2440mmH



10-11 SEPTEMBER 2026 | HONG KONG  
ASIA'S HUB FOR CLIMATE ACTION & SUSTAINABLE BUSINESS SOLUTIONS

## Perspective View

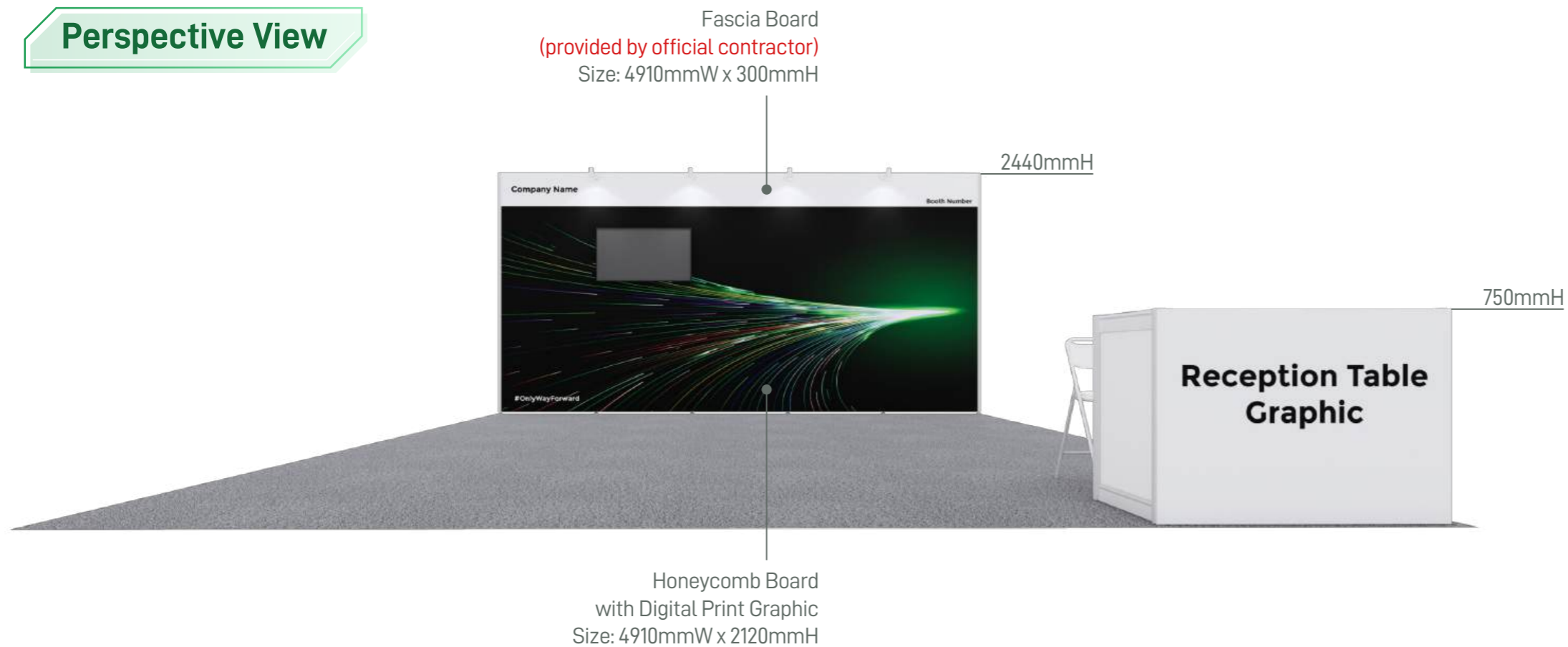

## Layout plan

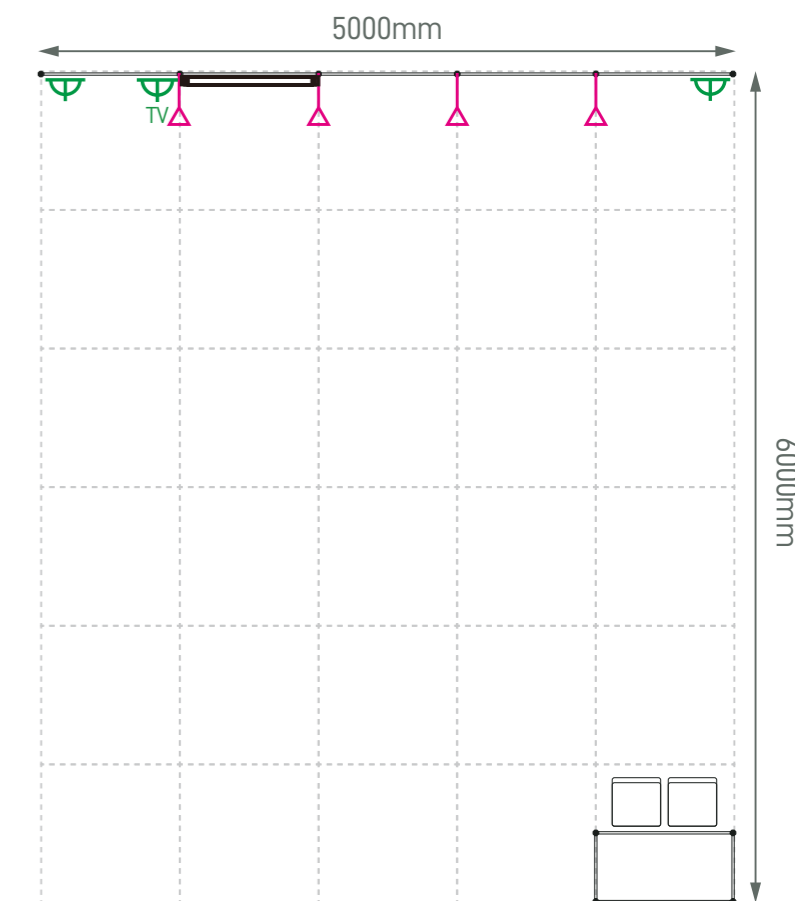

## Graphic Submission

Display Area / Graphic Size:  
4910mmW x 2120mmH

Legend	Qty
	LED Longarm Spotlight 4
	500W Square Pin Socket 2
	Reception Desk (1mW x 0.5mD x 0.75mH) 1
	Folding Chair 2
	43" LED TV 1
	Socket for LED TV 1

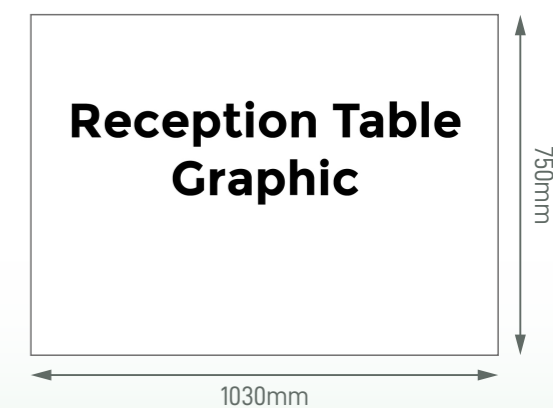
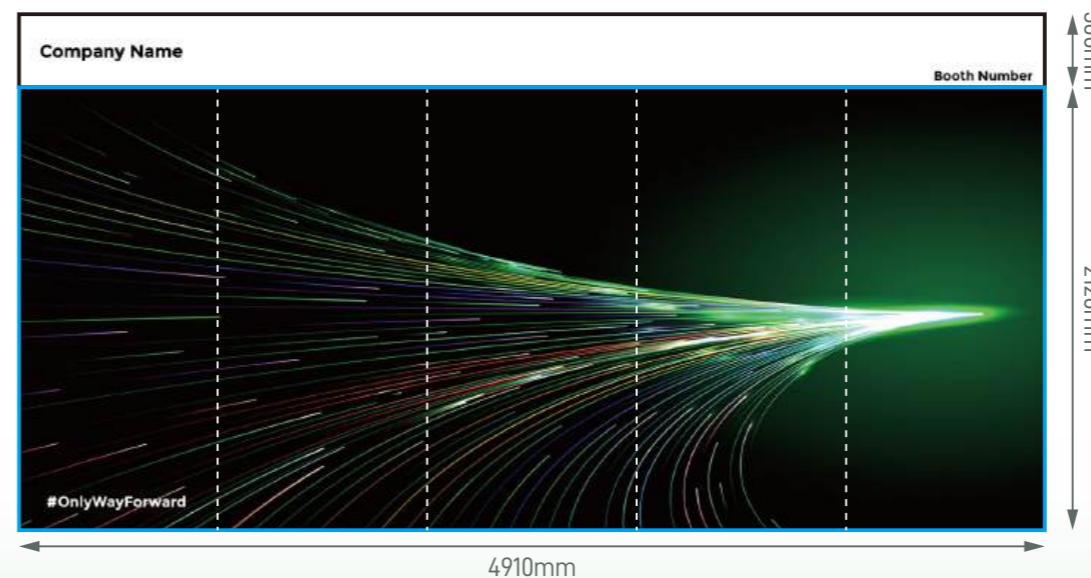

Revised Date: 27 May 2026 (V05)

# Standard Booth (R2) - 6m x 5m

Size: 6000mmL x 5000mmD x 2440mmH



10-11 SEPTEMBER 2026 | HONG KONG  
ASIA'S HUB FOR CLIMATE ACTION & SUSTAINABLE BUSINESS SOLUTIONS

## Perspective View



## Layout plan

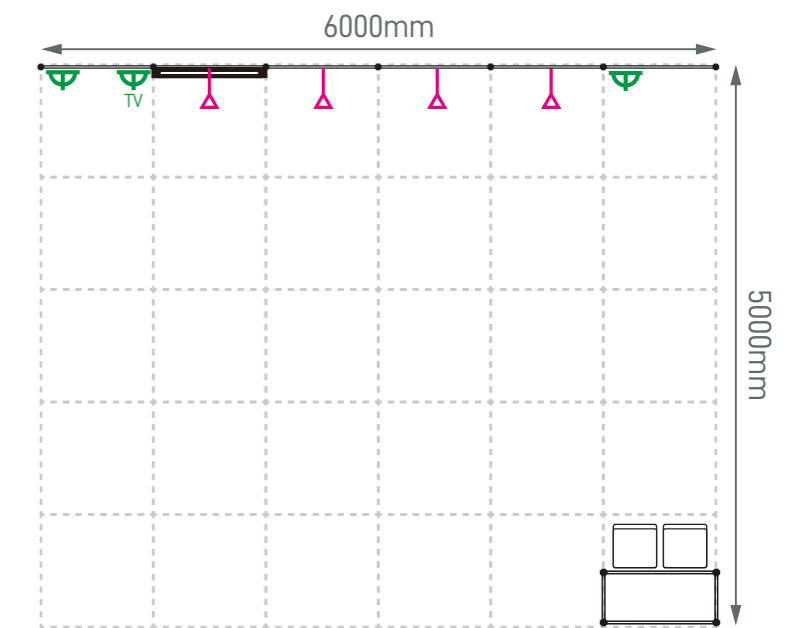

## Graphic Submission

Display Area / Graphic Size:  
5900mmW x 2120mmH

Legend	Qty
	LED Longarm Spotlight 4
	500W Square Pin Socket 2
	Reception Desk (1mW x 0.5mD x 0.75mH) 1
	Folding Chair 2
	43" LED TV 1
	Socket for LED TV 1

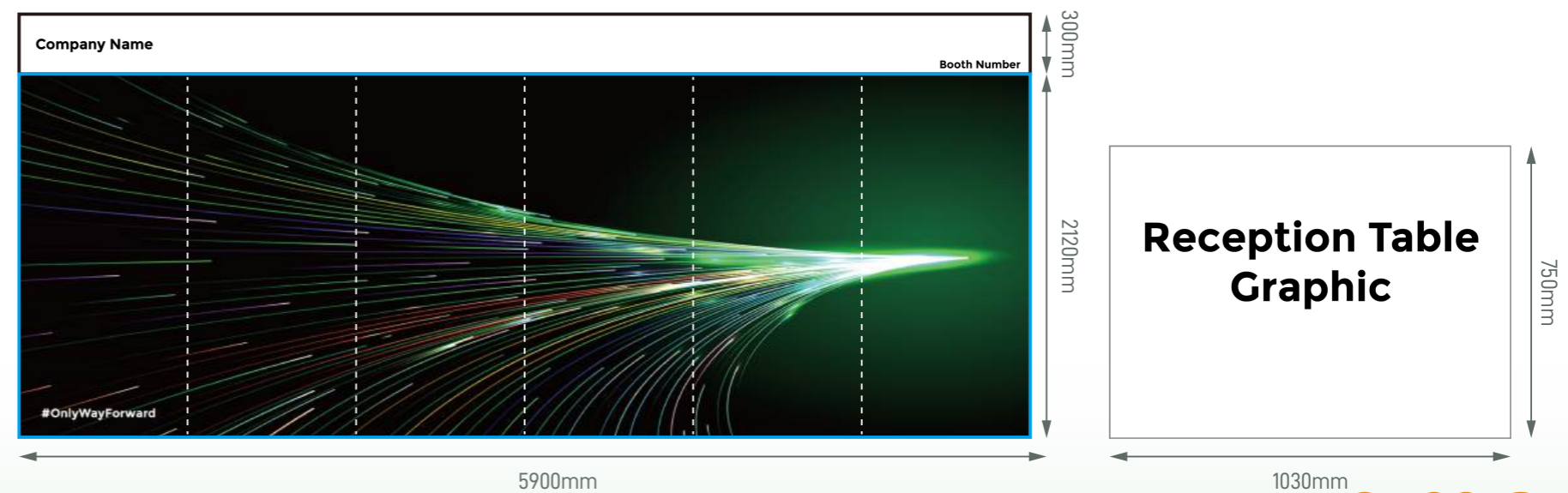

Revised Date: 27 May 2026 (V05)

# Standard Booth (S) - 8m x 4m

Size: 8000mmL x 4000mmD x 2440mmH



10-11 SEPTEMBER 2026 | HONG KONG  
ASIA'S HUB FOR CLIMATE ACTION & SUSTAINABLE BUSINESS SOLUTIONS

## Perspective View

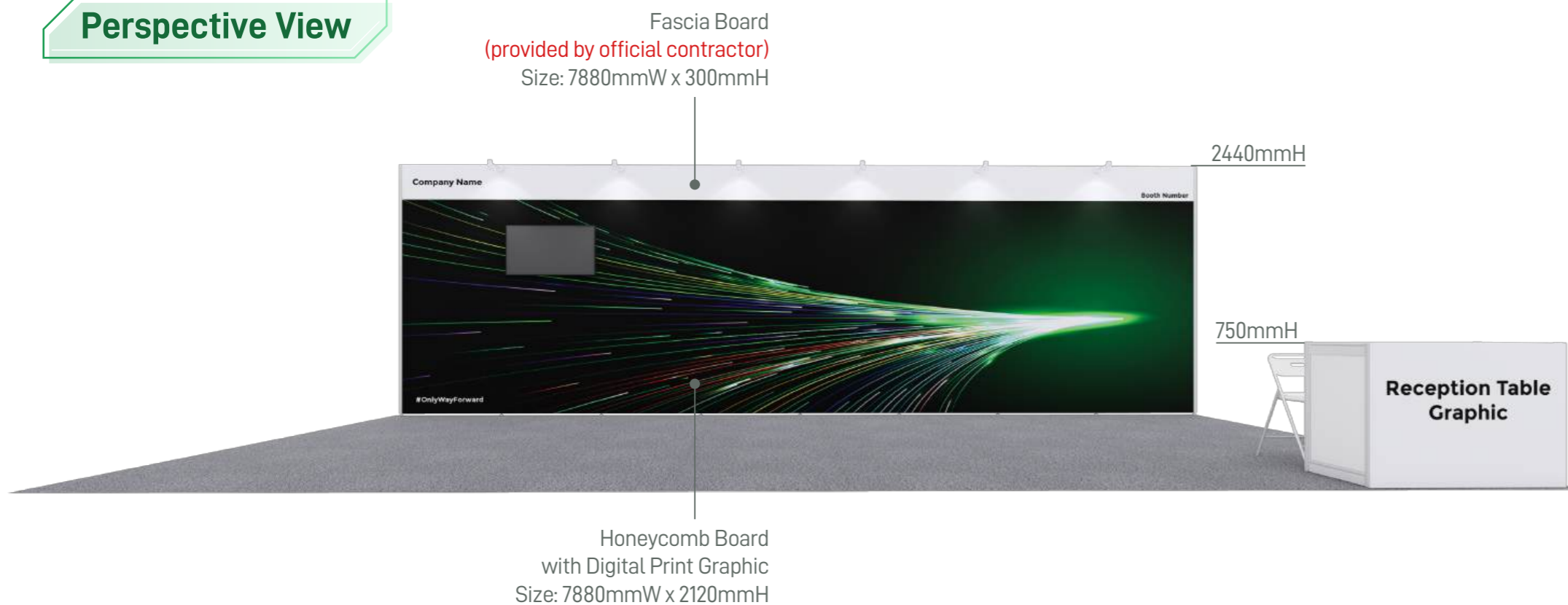

## Layout plan

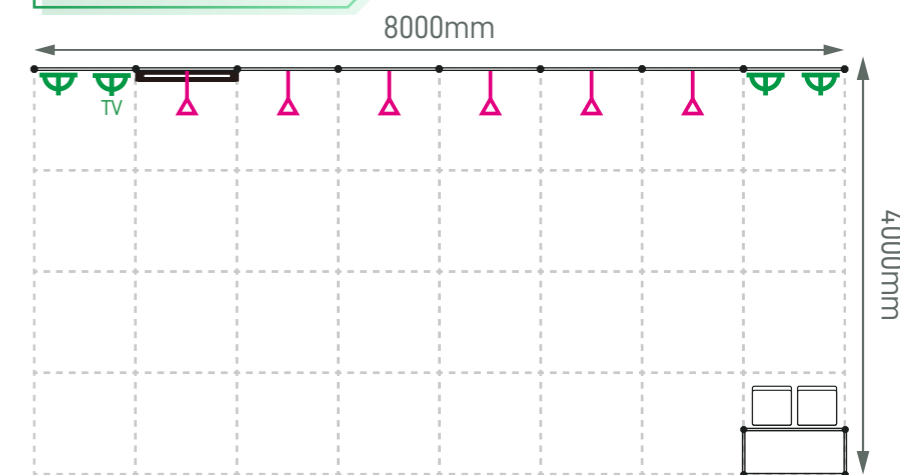

## Graphic Submission

Display Area / Graphic Size:  
7880mmW x 2120mmH

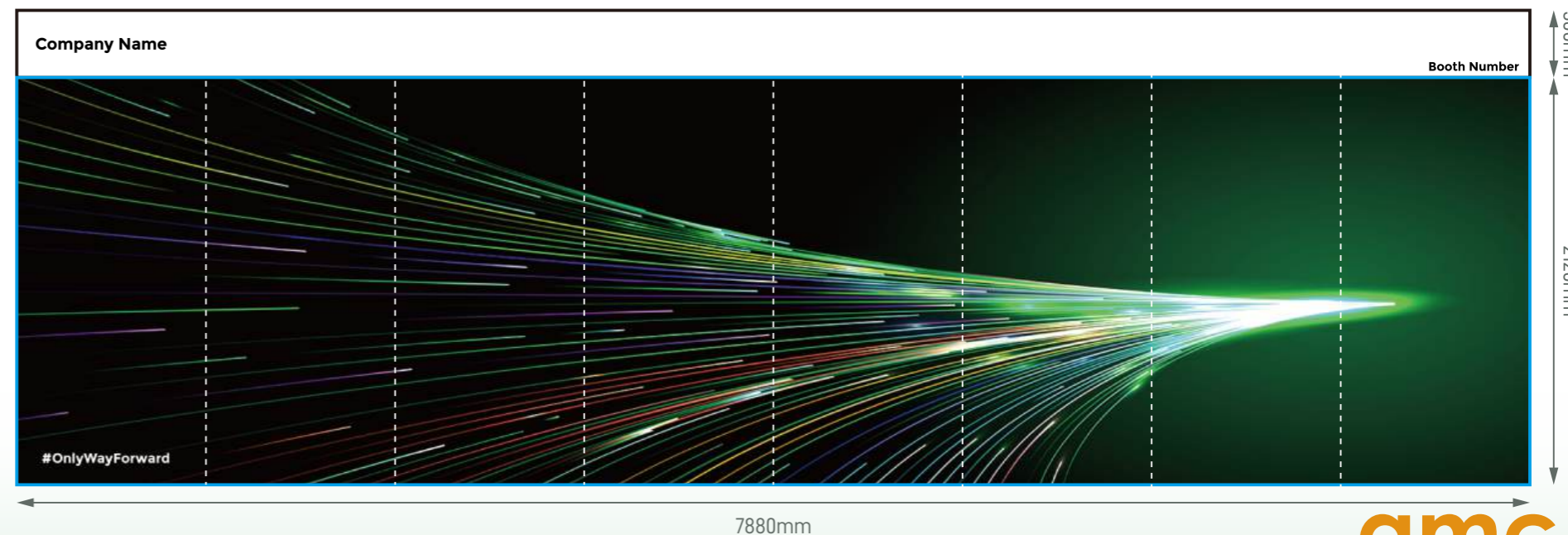

Legend	Qty
	LED Longarm Spotlight 6
	500W Square Pin Socket 3
	Reception Desk (1mW x 0.5mD x 0.75mH) 1
	Folding Chair 2
	43" LED TV 1
	Socket for LED TV 1

Revised Date: 27 May 2026 (V05)

# Standard Booth (S1) - 4m x 8m

Size: 4000mmL x 8000mmD x 2440mmH



10-11 SEPTEMBER 2026 | HONG KONG  
ASIA'S HUB FOR CLIMATE ACTION & SUSTAINABLE BUSINESS SOLUTIONS

## Perspective View

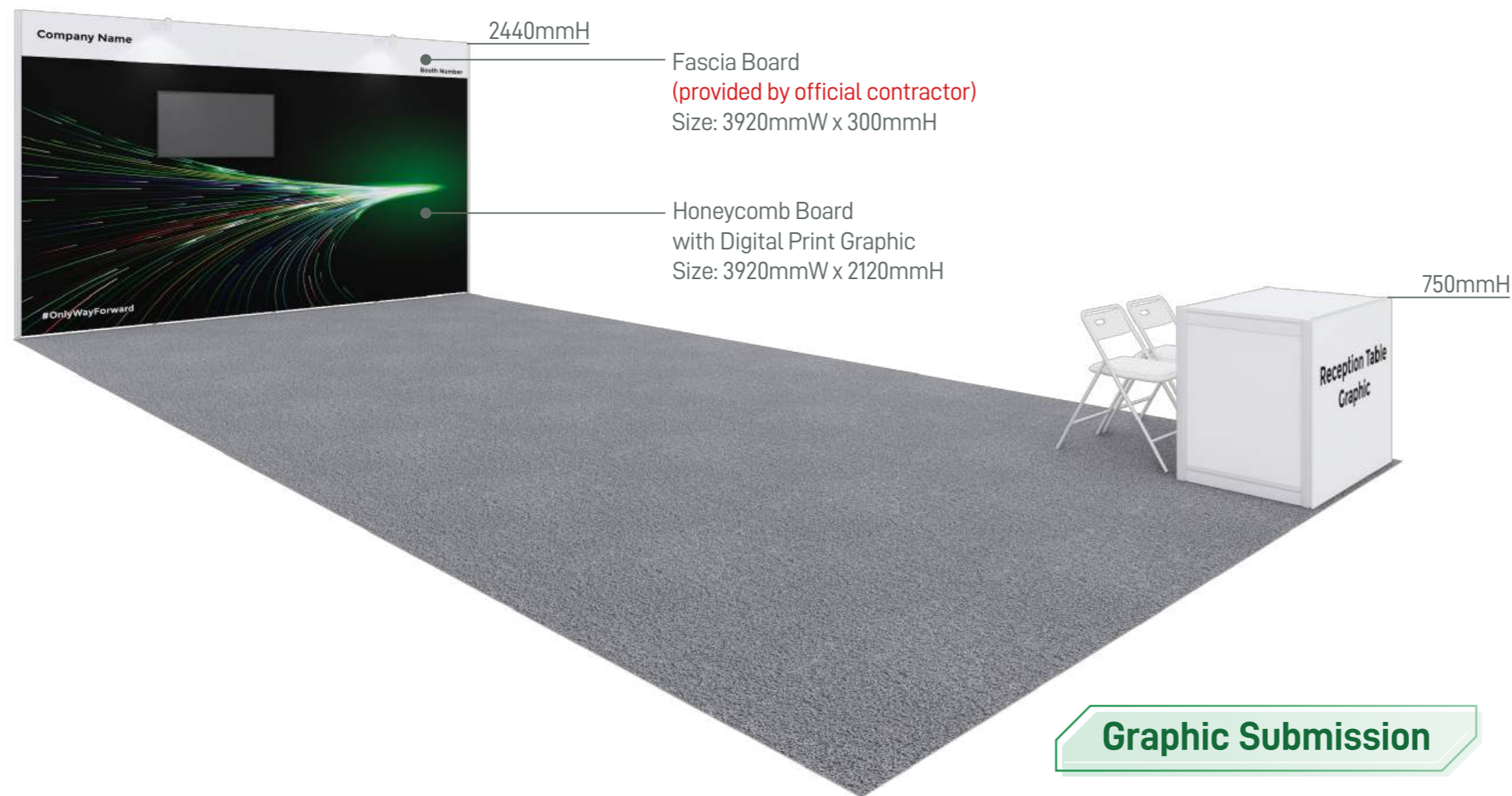

## Layout plan

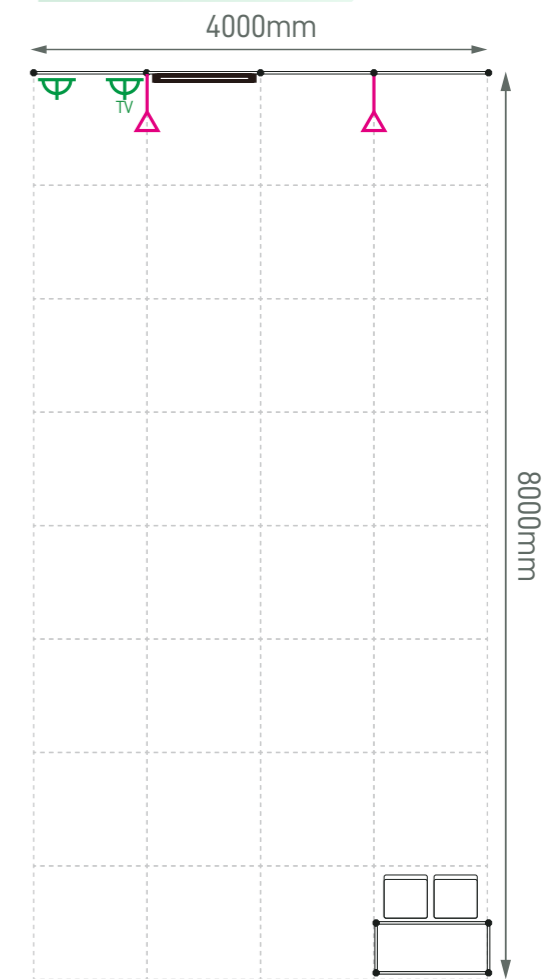

## Graphic Submission

Display Area / Graphic Size:  
3920mmW x 2120mmH

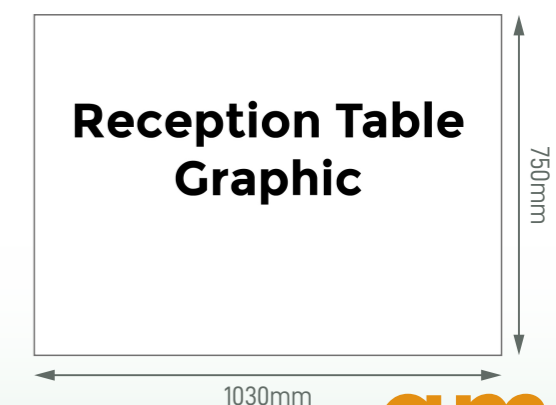
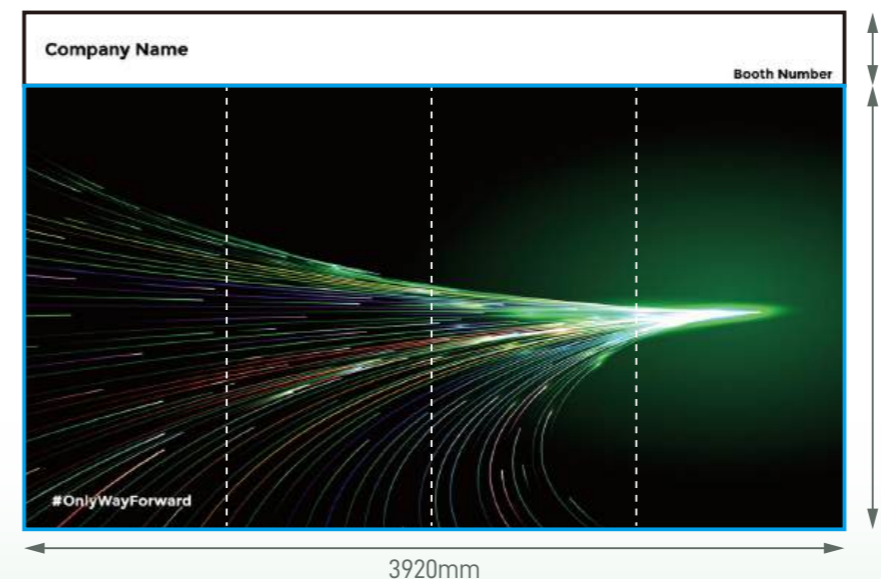

Legend	Qty
	LED Longarm Spotlight 2
	500W Square Pin Socket 1
	Reception Desk (1mW x 0.5mD x 0.75mH) 1
	Folding Chair 2
	43" LED TV 1
	Socket for LED TV 1

Revised Date: 27 May 2026 (V05)



# Standard Podium & Reception artwork dimensions

## Perspective View

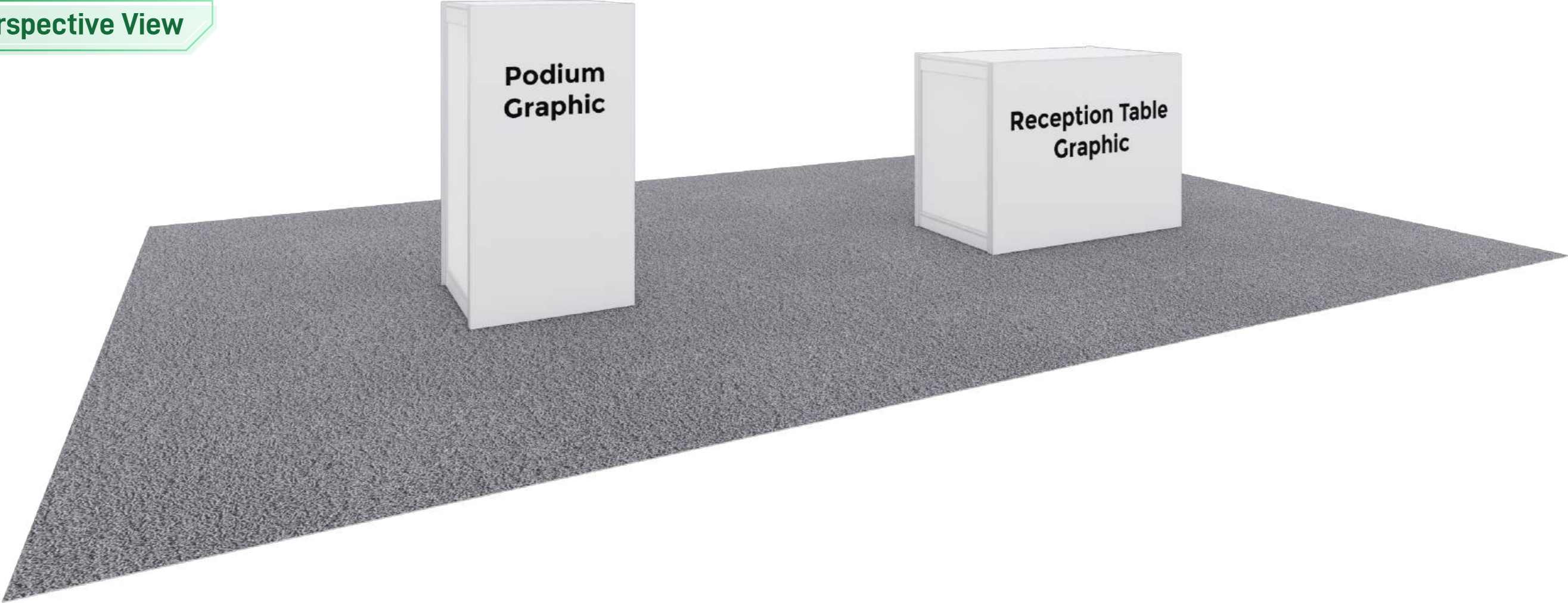

## Graphic Submission

